



# PRODUCT CATALOGUE

2022

# TABLE OF CONTENTS

About the Company.....	4
Cooperation .....	5
History of Company .....	6
Spring systems .....	8
Materials .....	10
MATTRESSES	
Balance .....	12
Compact .....	15
Trend.....	16
Sky.....	18
Home Sleep .....	20
Terapia New.....	22
Megatrend .....	24
S.O.U.L.....	27
Promo.....	28
Senses.....	29
Fitness .....	30
Serta Embrace .....	32
BEDS / SOFAS	
Beds.....	36
Compact forms .....	41
Upholstery materials.....	42
Cabinet furniture.....	44
Sofa .....	46
ACCESSORIES	
Protective covers.....	48
Pillows and blankets.....	49





# ASKONA MANUFACTURING FACILITY

the largest one among the manufacturers of goods for healthy sleep in Eastern Europe.



## PRIMARY PRODUCTION

- Polyurethane foam plant
- Polyester batting plant
- Coir plant
- Pocket spring unit manufacturing
- Tape and cardboard plant



## MANUFACTURING OF GOODS

- Mattress factory
- Bed factory
- Sofa factory
- Textile factory
- Modular cabinet furniture



## SALES OF PRODUCTS

- An extensive distribution network
- Export



## ADVANCED MANUFACTURING TECHNOLOGY

The largest 4-line conveyor system in Europe

In-house production of components

The facility area is over 160,000 sq.m.

## DAILY MANUFACTURING CAPACITY

**8,500**  
MATTRESSES

**1,200**  
PILLOWS

**600**  
BEDS

**400**  
SOFAS



### IN-HOUSE QUALITY LABORATORY

The only laboratory in Russia where mattresses are tested for strength, durability and other parameters.



### RESEARCH IN THE FIELD OF SOMNOLOGY

Together with doctors, we study the influence of sleep on human health and the quality of life. This research is taken into account when goods for healthy sleep are manufactured.



### RESEARCH OF CONSUMER PREFERENCES

Regular marketing research allows offering the customer individual integrated solutions for comfortable and healthy sleep.

# IT'S EASY TO BECOME OUR PARTNER!

Over many years, Askona has developed a successful algorithm of beneficial cooperation with our partners. Use the opportunity to create and promote your own business together with #1 company in Russia!

- 1 Askona offers several mattress lines that have already proved to be effective. Each collection has obvious benefits and a sustainably high demand
- 2 Guaranteed sales: B2B and B2C collections for any demand
- 3 Individual approach and special orders production are available
- 4 High turnover and profitability
- 5 A flexible approach to procurement prices, a transparent discount system
- 6 Regular sales offers aimed at maintaining a constantly stable demand
- 7 Design support
- 8 Warehouse-to-warehouse wholesale; the product range of more than 1,000 SKU
- 9 Professional expertise on the product development
- 10 A consistently high quality of products, extended warranty

## COMPETITIVE ADVANTAGES

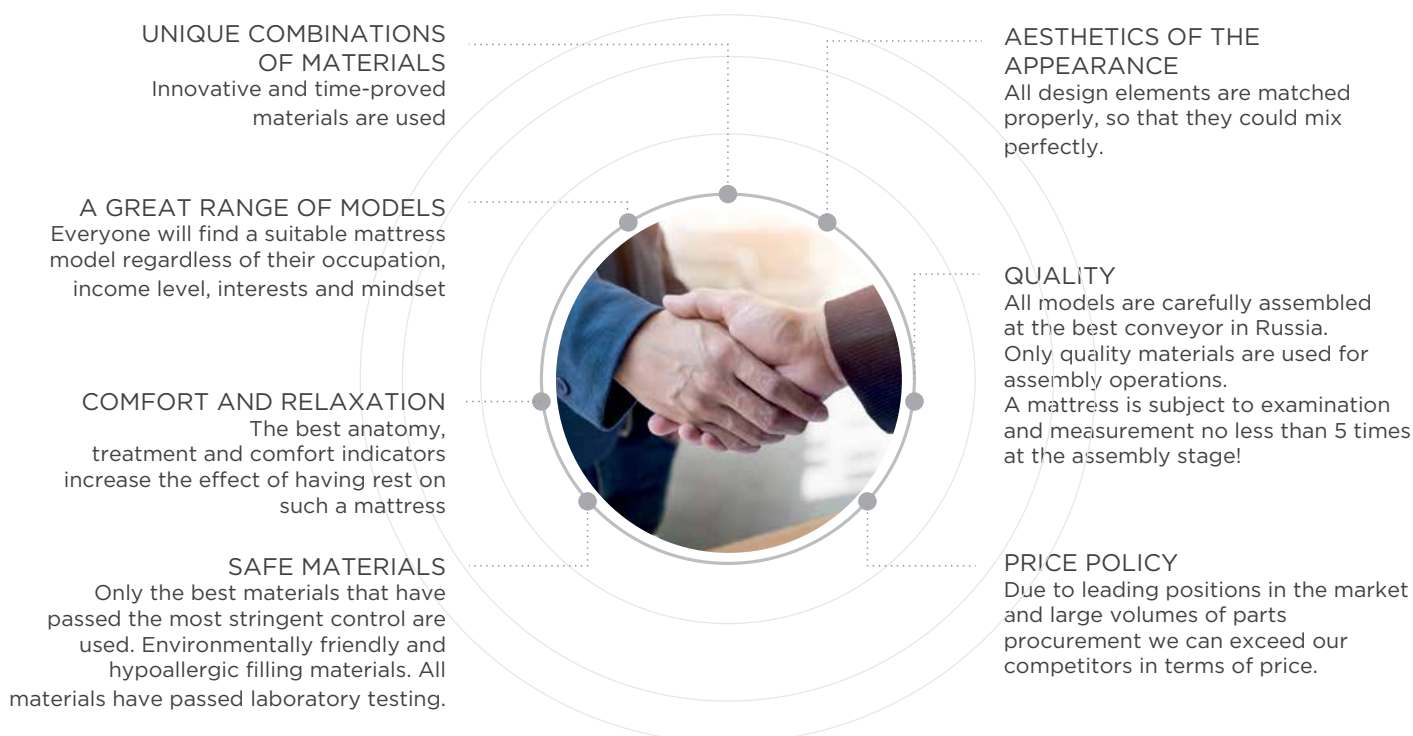



# HISTORY OF COMPANY

ASKONA IS THE RUSSIAN LARGEST VERTICALLY INTEGRATED RETAILER THAT SPECIALIZES IN MANUFACTURING THE ENTIRE RANGE OF PRODUCTS FOR HEALTHY SLEEP: MATTRESSES, BEDS, SOFAS, CABINET FURNITURE, GADGETS AND OTHER ACCESSORIES.

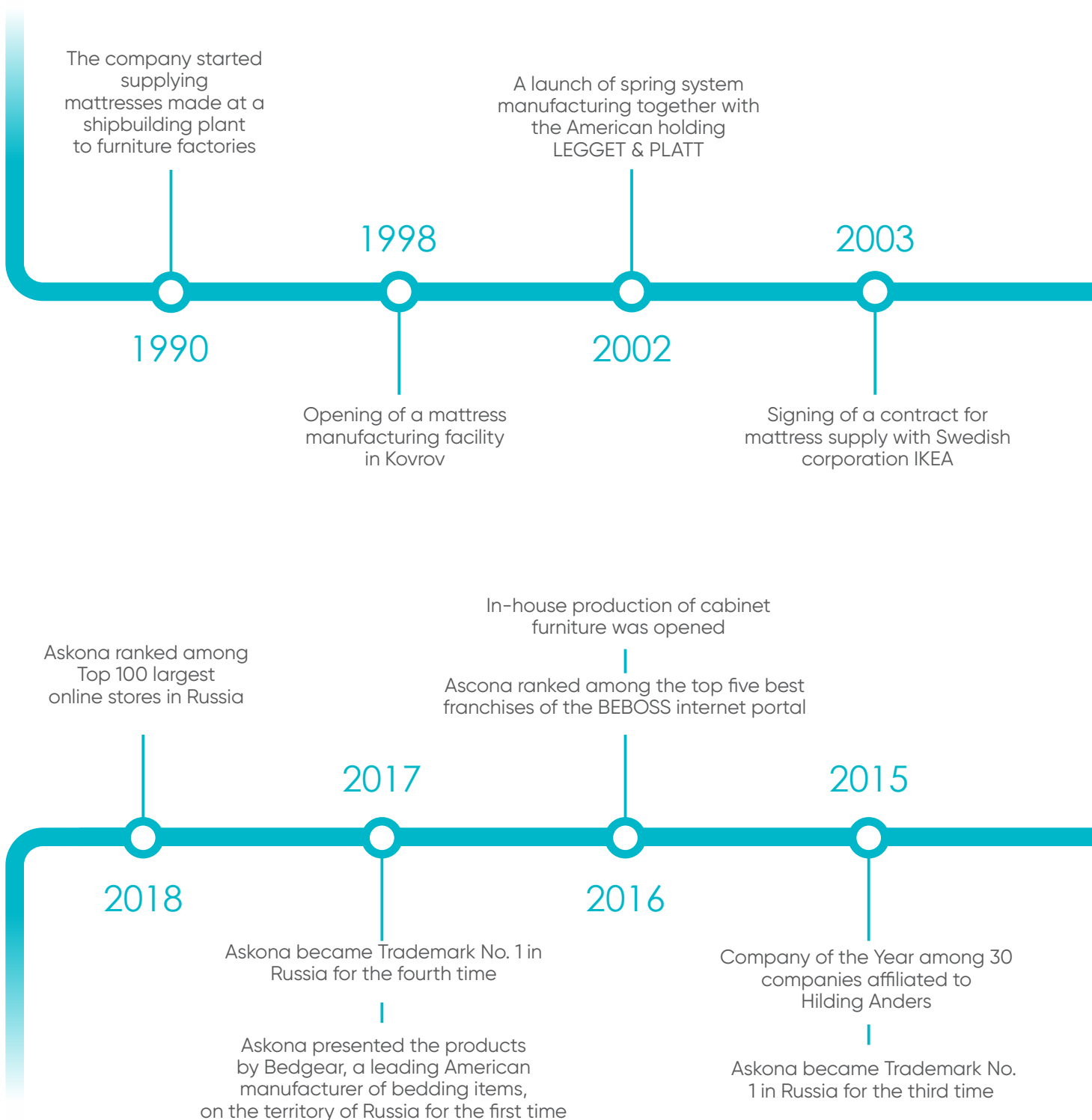

## OUR MISSION

We strive to make a person happy and healthy, giving strength and energy for the realization of his dreams

## OUR VISION

We are an internationally recognized expert brand in the field of generating individual spaces and the atmosphere for healthy sleep

## OUR VALUES

- Concern for the individuals
- Leadership
- Innovativeness
- Competence
- Transparency

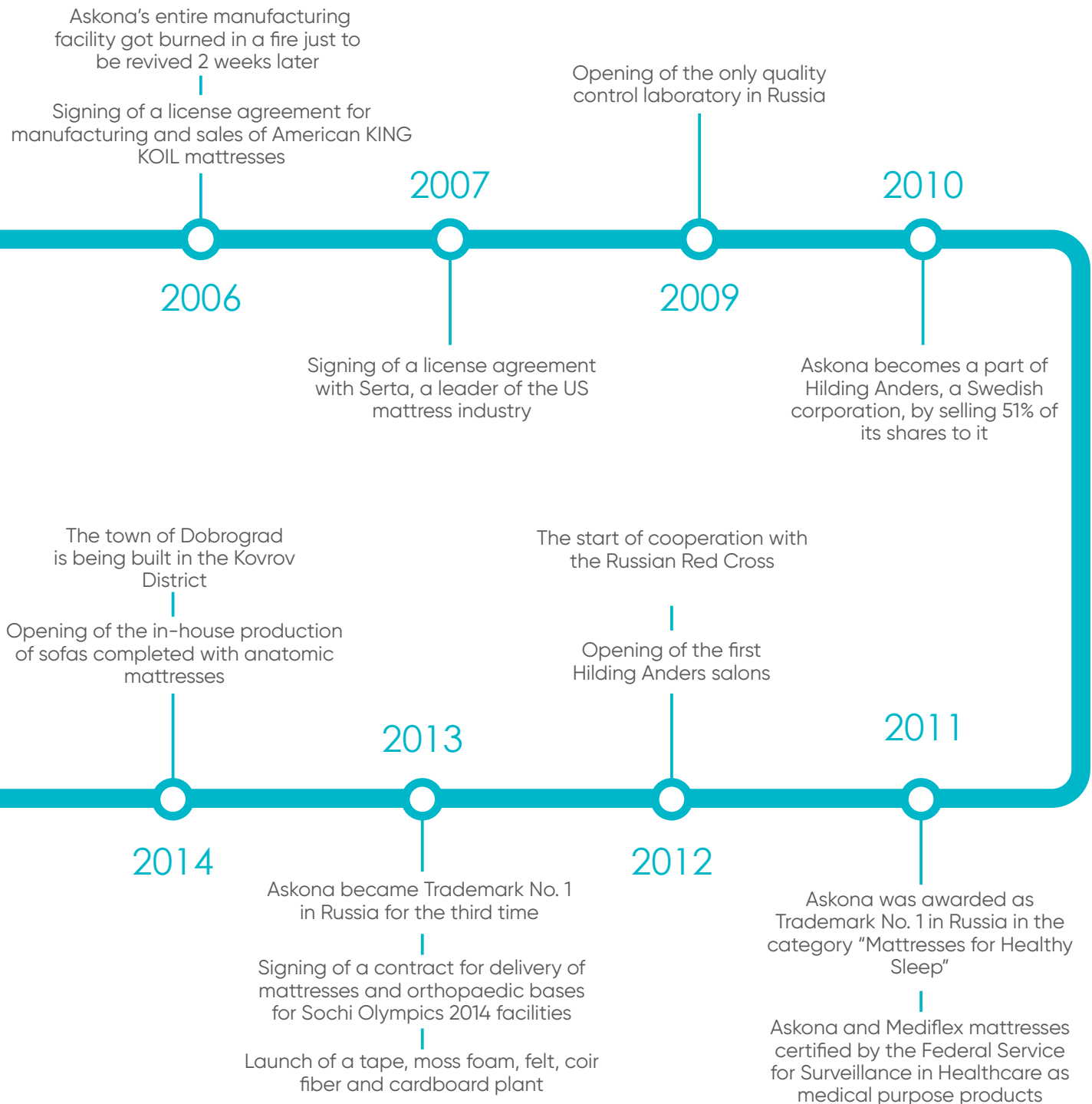



Spring blocks used in Askona mattresses are made of consistently high-quality wire using modern equipment.

The wire is subject to thermal and special anticorrosion treatment (hardening) at the manufacturing facility under a strict quality control in accordance with the request of Askona.

To maintain a consistent quality of products the Askona spring manufacturing organizes a multi-stage income quality control of raw materials and goods.

Each batch of wire is to be tested for rip, wrench, stratification and spinning ability.

Besides, springs undergo the normalization procedure at the Askona manufacturing facility (removal of residing tension after twisting) which guarantees consistent quality and a long lifecycle of spring blocks.



## BONNEL SPRING BLOCK

A classic spring block. Due to its design features it provides the best possible support and ensures even distribution of the human body weight across the surface of the mattress.

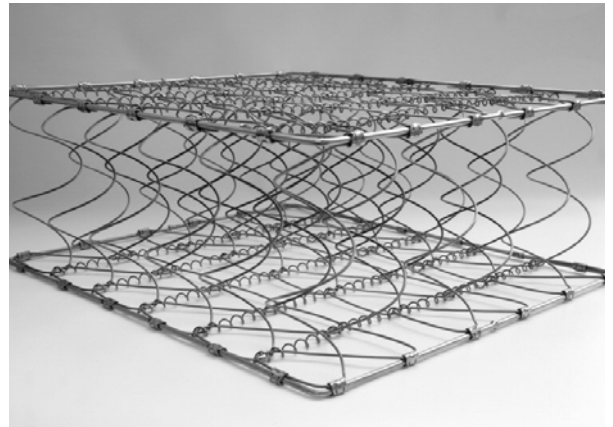

## TFK INDEPENDENT SPRING BLOCK

The spring block has special ergonomic and mechanical property. It consists of barrel springs each of which is placed in a closed bag and doesn't have any metallic connections with others. Compression of each spring in a block occurs independently of adjacent springs, so there is no "wave" effect.



## MULTIPOCKET INDEPENDENT SPRING BLOCK

The MultiPocket spring block comprises a large number of springs of a smaller diameter, each of which is located in a separate bag. Mattresses with such a spring block are very comfortable, since they support your spine better as if they followed the shape of your body due to a large number of springs. Unlike a standard TFK block they can endure a bigger load of up to 130 kg.



## SANDGLASS SPRING

A unique spring patented by Askona. An average spring is compressed pretty fast under pressure. The Sandglass Spring is compressed in three stages. At first expansion zones on top and at the bottom are compressed. The central part is compressed in the end – under the biggest load.

Usual springs are either rigid or weak. A Sandglass Spring can provide various sensations. Several levels of rigidness are concentrated in one spring at once to ensure universal comfort practically for any person.

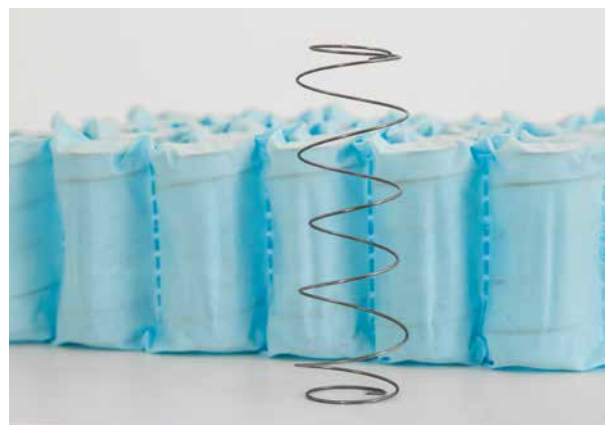



## ORTO FOAM

A highly elastic, hypoallergenic synthetic material with a double cell structure. The foam adjusts to the body anatomy in the most accurate manner to provide the perfect spine support and ensure a well-balanced microclimate for sleeping. The material is moisture-proof, non-toxic and can endure heavy loads for a long time.



## A FOAM WITH A MASSAGE EFFECT

It ensures air circulation inside the mattress by creating air pockets in cells. The massage effect is achieved due to protruding parts of a cell and provides softness and comfort.

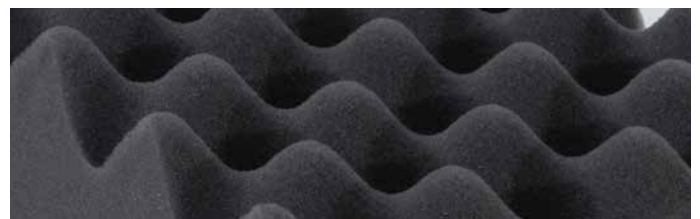

## CARBON FOAM

A safe and solid filling that adds to the softness of a mattress. Reshape easily, ensures air exchange inside the mattress and has an anti-bacterial effect.



## ORTO FOAM WITH A GREEN TEA PROOFING

A highly elastic, hypoallergenic synthetic material. It adjusts to the body anatomy in the most accurate manner to provide the perfect spine support and ensure a well-balanced microclimate for sleeping. A green tea proofing has a favorable effect on the skin tone and protects it from premature ageing.



## MEMORY FOAM

A modern material initially designed for the space industry. It's elastic and has a unique "memory" property – an ability to follow the shape of a human body and keep it for some time. Besides, it has antimicrobial characteristics.



## COIR

A filling made of compressed coconut fibers treated with a special compound based on natural latex. It's extremely resistant and durable and adds to the rigidity of a mattress.



## SISAL

The material is made of agave plants leaves. It doesn't conduct static electricity. The material is solid and durable.



## MOSS FOAM

A non-woven synthetic canvas made of polyether fibers. It neither generates dust nor causes allergy. It adds to the volume of the mattress upper point.



## FELT

A strong and resilient material made of natural raw. It serves as a rigid insulating layer between springs and a soft filling.



## WHITE FELT

Felt is made of cleaned cotton raw; it's very thick and durable. It spreads the pressure across the surface of the spring block.



## HOLLOWFIBER

The hypoallergenic material consists of unique hollow spiral fibers. Its structure ensures great resilience and durability. Without absorbing smells or dragging dust, it preserves hygienic cleanness for a long time.



## LINEN

Heat-bonded 100% linen is an environmentally friendly material which excludes the possibility that the mattress contains formaldehyde. Linen derives moisture, creates a useful microclimate and neutralizes smells.



## SPUNBOND

A non-woven synthetic canvas of high density. It adds to the material's strength and protects softer layers from abrasion caused by a spring block.



## LATEX

A porous, resilient, durable material. It is made of a hevea rubber tree foamed juice. Thermally stable, with an antiseptic power. It minimizes reverse pressure on soft body parts.





## ASKONA BALANCE MATTRESSES ARE THE BEST POSSIBLE SOLUTION FOR THOSE WHO PREFER A HIGH QUALITY AT A REASONABLE PRICE.

Askona Balance mattresses – now comfortable and healthy sleep has become even more affordable.

The mattress chosen correctly is a prerequisite of health, success and prosperity. Askona Balance mattresses meet all the requirements in terms of environmental friendliness and safety, provide the maximal body adaptation and a required level of comfort. Askona Balance mattresses are the best possible solution for those who prefer a high quality at a reasonable price.

A well-balanced assortment of the Askona Balance Collection will allow everybody who prefers the most favorable price for the most worthy quality level to choose a mattress to their liking.

BALANCE MATTRESSES ENSURE COMFORTABLE SUPPORT OF YOUR BODY IN YOUR SLEEP DUE TO THE BEST POSSIBLE COMBINATION OF LAYERS IN THEIR COMPOSITION



**Jacquard**  
A thick mattress material. A special thread plaiting increases durability. Composition: 50% polyester, 50% thick synthetic fiber (Aerlan).



**A highly elastic foam**  
The foam adjusts to the body anatomy in the most accurate manner to provide the perfect spine support and ensure a well-balanced microclimate for sleeping.



**Coir**  
A filling made of compressed coconut fibers treated with a special compound based on natural latex. It's extremely resistant and durable and adds to the rigidity of a mattress.



## PRACTICE



A double-sided mattress



Height mm



Warranty for the mattress\*



Max load for 1 accommodation



Mattress rigidity



1. Moss foam padded jacquard
2. A highly elastic foam
3. Felt
4. Bonnel spring block
5. Mattress edge reinforcement

## PALMA



A double-sided mattress



Height mm



Warranty for the mattress\*



Max load for 1 accommodation



Mattress rigidity



1. Moss foam padded jacquard
2. A highly elastic foam
3. Coir fiber
4. Bonnel spring block
5. Mattress edge reinforcement

## SMART



A double-sided mattress



Height mm



Warranty for the mattress\*



Max load for 1 accommodation



Mattress rigidity



1. Moss foam padded jacquard
2. A highly elastic foam
3. Resilient spunbond
4. Bonnel spring block
5. Mattress edge reinforcement

\* An extended warranty for the purchase of a mattress with a cover.

## FORMA





 A double-sided mattress  
 Height mm: 170  
 Warranty for the mattress\*  
 Max load for 1 accommodation



1. Moss foam padded jacquard
2. A highly elastic foam
3. Felt
4. An independent spring block of enhanced reliability
5. Mattress edge reinforcement

## STATUS







 A double-sided mattress  
 Height mm: 190  
 Warranty for the mattress\*  
 Max load for 1 accommodation



1. Moss foam padded jacquard
2. A highly elastic foam
3. Coir fiber
4. An independent spring block of enhanced reliability
5. Mattress edge reinforcement

## LUX



 A double-sided mattress  
 Height mm: 190  
 Warranty for the mattress\*  
 Max load for 1 accommodation



1. Moss foam padded knitted fabric
2. A highly elastic foam
3. Felt
4. An independent spring block of enhanced reliability
5. Mattress edge reinforcement

## PRESTIGE



 A double-sided mattress  
 Height mm: 210  
 Warranty for the mattress\*  
 Max load for 1 accommodation



1. Moss foam padded knitted fabric
2. A highly elastic foam
3. Coir fiber
4. An independent spring block of enhanced reliability
5. Mattress edge reinforcement

\* An extended warranty for the purchase of a mattress with a cover.



## ASKONA COMPACT – A MATTRESS IN A ROLL

To make transportation of mattresses to your home, summer house or to your relatives as a nice gift easier a collection of roll-packaged mattresses has been designed.

In a store a mattress looks like a roll, so that one can buy a mattress and take it home immediately. It's easy to transport it to the point of destination in a trunk of a passenger car.

As soon as the mattress package is opened, it returns to its original sizes soon ('unrolls'). Easy resize is possible due to the use of highly elastic materials as a mattress basis.

### EFFECT LOW

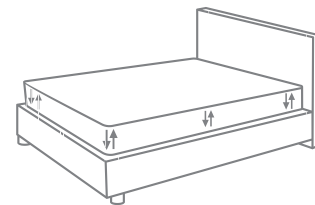
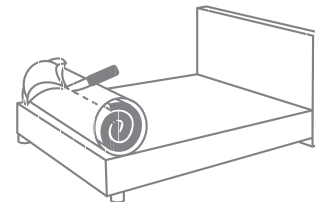

1. Put the rolled mattress along the edge of the bed, settle the fold of the mattress toward the center of the bed and cut the package.
2. Unfold the mattress and arrange it on the bed as per the scheme with its bend down.
3. Make a cut on the vacuum packaging – the mattress will recover and get back to its initial shape.

\* An extended warranty for the purchase of a mattress with a cover.





## A COLLECTION OF CLASSIC TIME-PROVED "SNOW WHITE" MATTRESSES

ASKONA TREND is created for people that appreciate traditions and prefer a classic style when it comes to the interior. They are not ready to spend a lot on a new mattress, and yet, they want to get a quality product and have healthy sleep.



## LINE



 A double-sided mattress  
 Height mm: 180  
 Warranty for the mattress\*  
 Max load for 1 accommodation  
   Mattress rigidity

1. Knitted fabric padded with highly elastic foam
2. Felt
3. The Bonnel spring block reinforced with two metal frames across the edge and polyurethane foam in the corners

## LUCKY





 A double-sided mattress  
 Height mm: 200  
 Warranty for the mattress\*  
 Max load for 1 accommodation  
   Mattress rigidity

1. Moss foam padded jacquard
2. Coir
3. An independent spring block with springs of increased height
4. Edge reinforcement

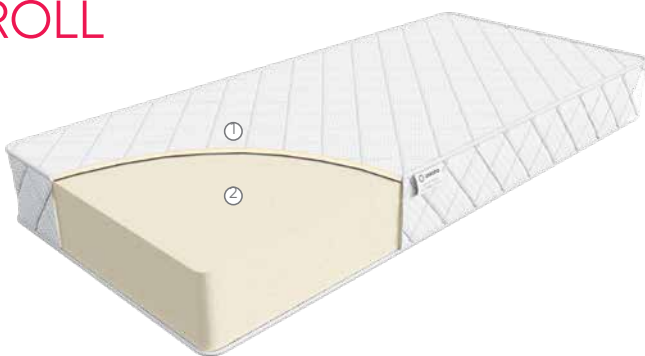
## ROLL







 A double-sided mattress  
 Height mm: 160  
 Warranty for the mattress\*  
 Max load for 1 accommodation  
   Mattress rigidity

1. Moss foam padded jacquard
2. A highly elastic foam

 A mattress in a roll

## PRIME



 A double-sided mattress  
 Height mm: 220  
 Warranty for the mattress\*  
 Max load for 1 accommodation  
   Mattress rigidity

1. Knitted fabric padded with highly elastic foam
2. Coir
3. An independent spring block with springs of increased height
4. Edge reinforcement

\* An extended warranty for the purchase of a mattress with a cover.





## STANDART

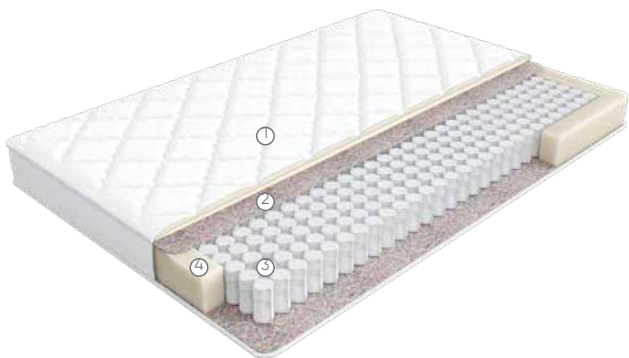

 A double-sided mattress
  Height mm 160
  Warranty for the mattress\*
  Max load for 1 accommodation



1. Highly elastic foam cotton jacquard
2. Felt
3. An independent spring block
4. Mattress edge support reinforcement system

## STANDART OPTION

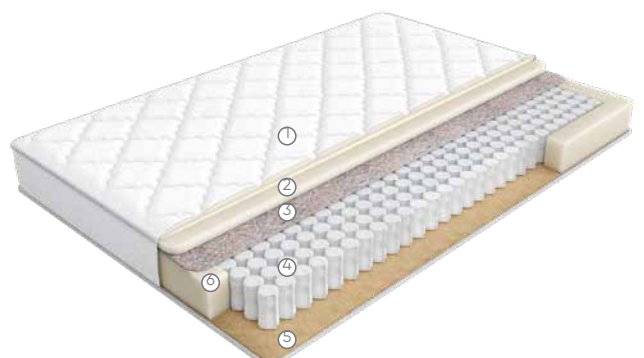

 Many-sided mattress
  Height mm 180
  Warranty for the mattress\*
  Max load for 1 accommodation

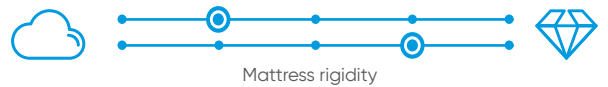

1. Highly elastic foam cotton jacquard
2. Highly elastic foam
3. Felt
4. An independent spring block
5. Coir plate
6. Mattress edge support reinforcement system

\* An extended warranty for the purchase of a mattress with a cover.

## THE BEST COMBINATIONS OF MATERIALS AT AFFORDABLE PRICES



**CottonCare fabric proofing**  
Fabric proofing as a finishing touch for fibers restrains the growth of microorganisms on the fabric and serves as a protective barrier from pathogenic microorganisms and dust mites for the skin. It also has a self-purification property.



**OrtoFoam highly elastic foam**  
It's notable for improved air exchange in the comfort layers of the mattress, follows the body shape to reduce the "negative" reverse pressure on soft fabrics.



**Unique design**  
A combination of snow white fabric and a toise with a trendy geometric design.



## BLUE

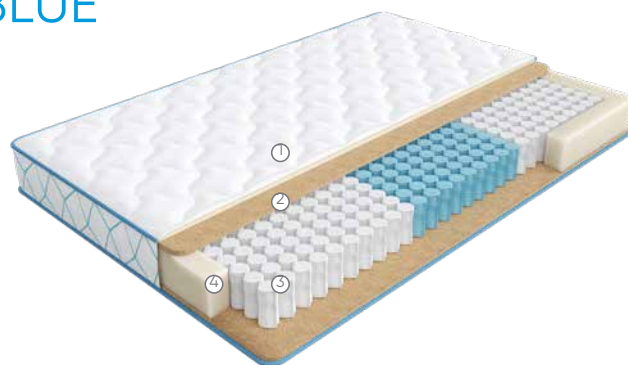

A double-sided mattress



Height mm



Warranty for the mattress\*



Max load for 1 accommodation



Mattress rigidity



1. Highly elastic foam padded bulky knitted fabric with a CottonCare proofing
2. Coir plate
3. A three zoned 3ZoneFlex spring block
4. Mattress edge support reinforcement system

## ICE

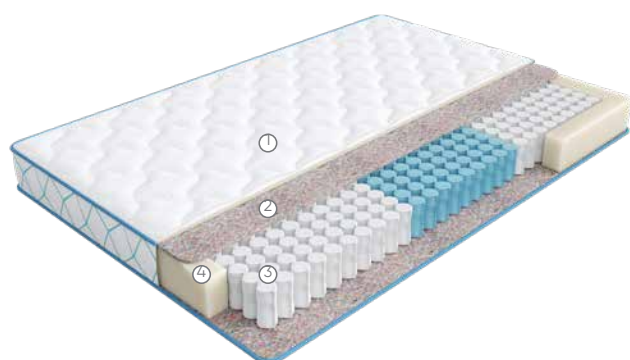

A double-sided mattress



Height mm



Warranty for the mattress\*



Max load for 1 accommodation



Mattress rigidity



1. Highly elastic foam padded bulky knitted fabric with a CottonCare proofing
2. Felt
3. A three zoned 3ZoneFlex spring block
4. Mattress edge support reinforcement system

## FROST

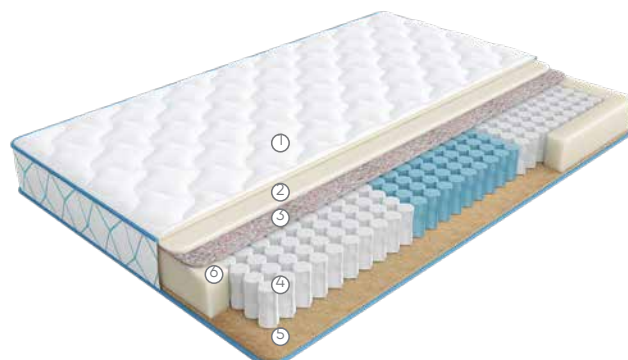

Many-sided mattress



Height mm



Warranty for the mattress\*



Max load for 1 accommodation



Mattress rigidity



1. Highly elastic foam padded bulky knitted fabric with a CottonCare proofing
2. OrtoFoam
3. Felt
4. A three zoned 3ZoneFlex spring block
5. Coir plate
6. Mattress edge support reinforcement system

\* An extended warranty for the purchase of a mattress with a cover.



**HOME SLEEP** MATTRESSES WILL GRANT YOU A SENSE OF SECURITY AND EMOTIONAL SATISFACTION, AND NATURAL MATERIALS WILL EMPHASIZE SPECIAL COMFORT



**CottonCare fabric proofing**  
Fabric proofing as a finishing touch for fibers restrains the growth of microorganisms on the fabric and serves as a protective barrier from pathogenic microorganisms and dust mites for the skin. It also has a self-purification property.



**FreeStat System**  
It reduces body tension intensively which leads to a decreased cortisol level and a deeper and more relaxed sleep.

## Base

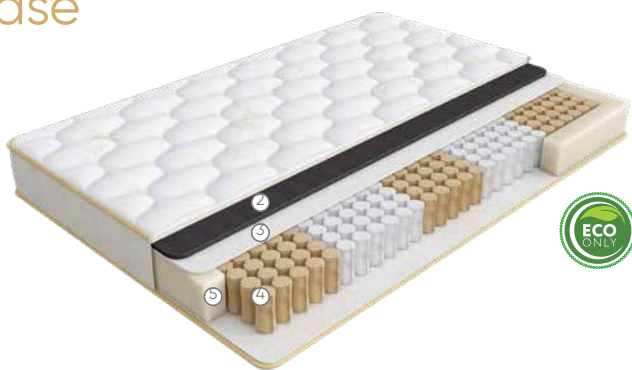

- A single-sided mattress
- Height mm  
 200
- Warranty for the mattress\*  
 10 years
- Max load for 1 accommodation  
 140



1. Highly elastic foam padded knitted fabric with a CottonCare proofing
2. Highly elastic CarbonFoam with antibacterial proofing
3. Linen
4. A five zoned 5ZoneFlex spring block
5. Mattress edge support reinforcement system

## Vesta

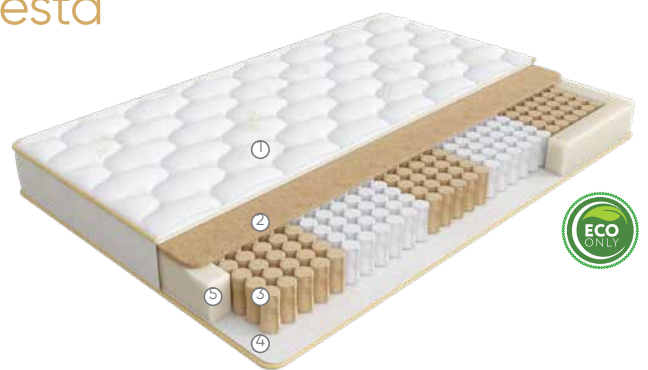

- A single-sided mattress
- Height mm  
 190
- Warranty for the mattress\*  
 10 years
- Max load for 1 accommodation  
 140



1. Highly elastic foam padded knitted fabric with a CottonCare proofing
2. Coir
3. A five zoned 5ZoneFlex spring block
4. Linen
5. Mattress edge support reinforcement system

\* An extended warranty for the purchase of a mattress with a cover.



## Massage

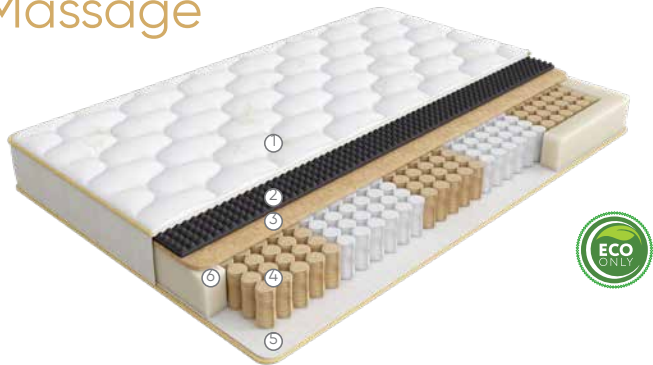

A single-sided mattress



Height mm



Warranty for the mattress\*



Max load for 1 accommodation



Mattress rigidity

1. Highly elastic foam padded knitted fabric with a CottonCare proofing
2. Highly elastic CarbonFoam with antibacterial proofing and a massage effect
3. Coir
4. A five zoned 5ZoneFlex spring block
5. Linen
6. Mattress edge support reinforcement system

## Safe

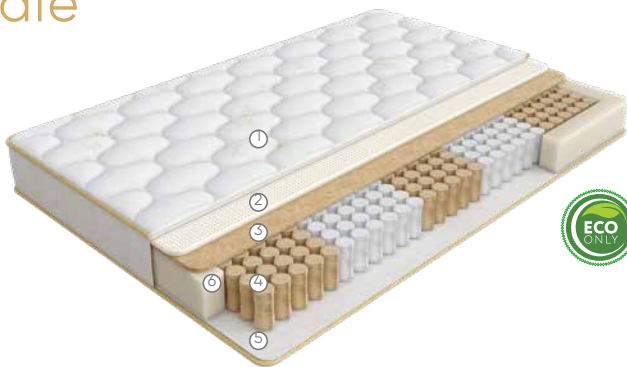

A single-sided mattress



Height mm



Warranty for the mattress\*



Max load for 1 accommodation

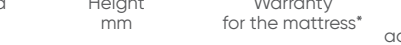

Mattress rigidity

1. Highly elastic foam padded knitted fabric with a CottonCare proofing
2. Latex
3. Coir
4. A five zoned 5ZoneFlex spring block
5. Linen
6. Mattress edge support reinforcement system

## Viva

FOR COUPLES WITH A SIGNIFICANT WEIGHT DIFFERENCE.  
INDIVIDUAL RIGIDITY OF EACH HALF OF THE MATTRESS

This mattress is designed for family couples where partners prefer different mattress rigidity or for couples with a significant weight difference. Viva is a double-sided mattress based on unique combination independent pocket spring blocks. Such a spring block consists of two parts that divide the mattress into two halves: a soft one and a rigid one. Springs of different diameters are used in a soft half and a rigid one.

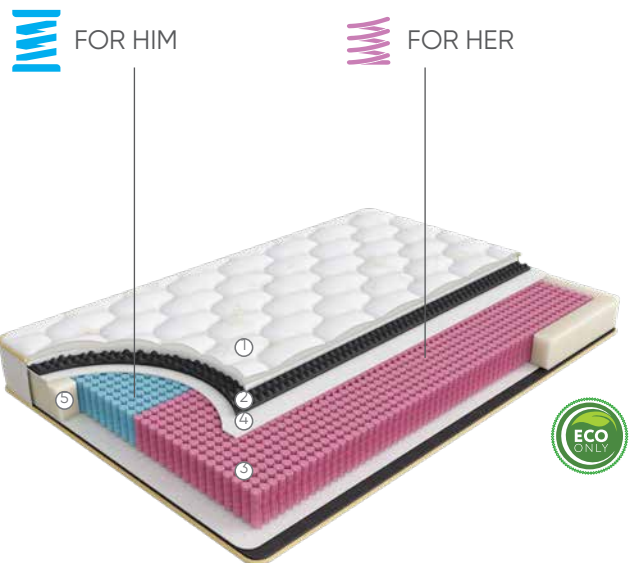

A double-sided mattress



Height mm



Warranty for the mattress\*



Max load for 1 accommodation



Mattress rigidity





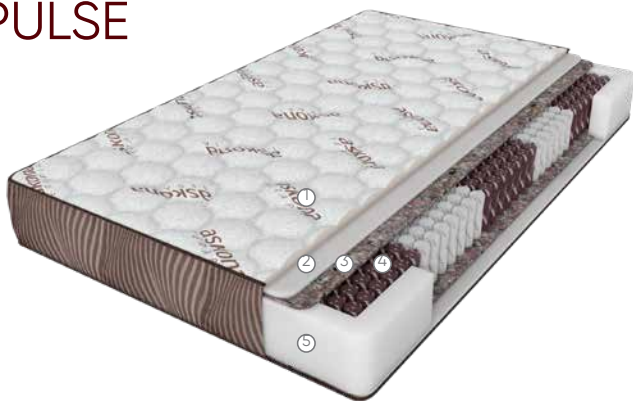

1. Highly elastic foam padded knitted fabric with a CottonCare proofing
2. A highly elastic CarbonFoam with a micro-massage effect
3. A five zoned 5ZoneFlex spring block with springs made of wire of various diameters
4. Linen
5. Mattress edge support reinforcement system

\* An extended warranty for the purchase of a mattress with a cover.



## PULSE







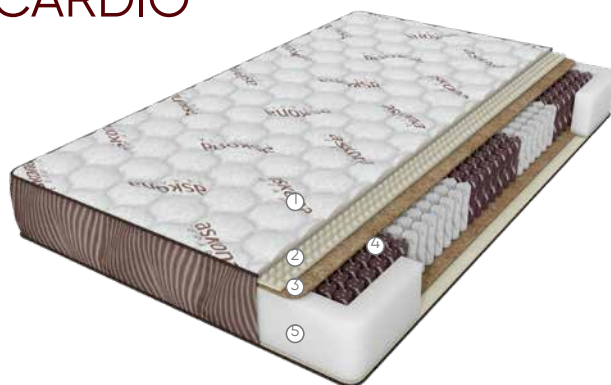

 A double-sided mattress  
 Height mm  
 Warranty for the mattress\*  
 Max load for 1 accommodation  
   Mattress rigidity

1. Moss foam padded bulky Belgian knitted fabric
2. Orto Foam
3. Felt
4. A five zoned Sandglass Extra independent spring block  
550 springs per a sleeping accommodation
5. Mattress edge reinforcement

## CARDIO



 A double-sided mattress  
 Height mm  
 Warranty for the mattress\*  
 Max load for 1 accommodation  
   Mattress rigidity

1. Highly elastic moss foam padded bulky Belgian knitted fabric
2. Orto Foam with a micro-massage effect
3. Coir plate
4. A five zoned Sandglass Extra independent spring block  
550 springs per a sleeping accommodation
5. Mattress edge reinforcement

\* An extended warranty for the purchase of a mattress with a cover.



## UNIVERSAL ANATOMIC MATTRESSES FOR PREVENTION OF DISEASES CAUSED BY SLEEP DISORDERS.



Do you want to be active and full of energy all the time? Consider healthy sleep! Askona, the largest manufacturer of goods for sleep in Russia, presents the collection of mattresses that will take care of your health during the night, so that you could feel great when the day comes.

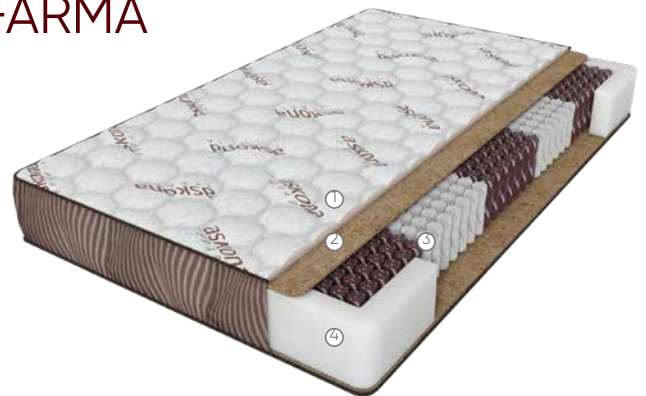

### FARMA







-   
A double-sided mattress
-   
Height mm
-   
Warranty for the mattress\*
-   
Max load for 1 accommodation

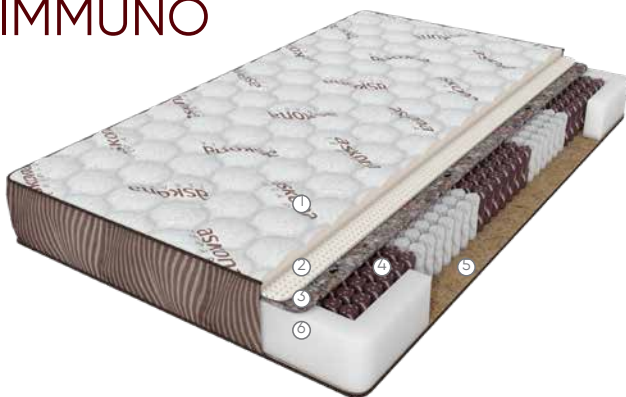

    
Mattress rigidity

1. Moss foam padded bulky Belgian knitted fabric
2. Coir plate
3. A five zoned Sandglass Extra independent spring block 550 springs per a sleeping accommodation
4. Mattress edge reinforcement

### IMMUNO



-   
Many-sided mattress
-   
Height mm
-   
Warranty for the mattress\*
-   
Max load for 1 accommodation

    
Mattress rigidity

1. Highly elastic moss foam padded bulky Belgian knitted fabric
2. Latex
3. Felt
4. A five zone Sandglass Extra independent pocket spring block 550 springs per a sleeping accommodation
5. Coir plate
6. Mattress edge reinforcement

### SPECTRA

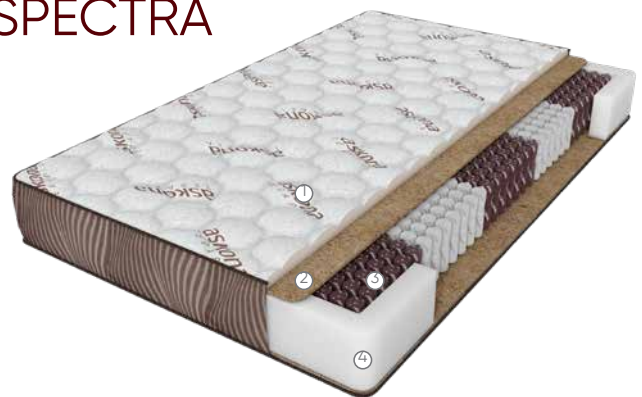

-   
A double-sided mattress
-   
Height mm
-   
Warranty for the mattress\*
-   
Max load for 1 accommodation

    
Mattress rigidity

1. Highly elastic moss foam padded bulky Belgian knitted fabric
2. Coir plate
3. A five zoned Sandglass Extra independent spring block 550 springs per a sleeping accommodation
4. Mattress edge reinforcement

\* An extended warranty for the purchase of a mattress with a cover.





**ASKONA MEGATREND IS**  
A COLLECTION OF SUPER-DURABLE MATTRESSES!  
POPULAR MATTRESSES DESIGNED FOR PEOPLE  
OF VARIOUS WEIGHT CATEGORIES!



Exclusive Belgium knitted fabric



Natural materials



A three zoned 3ZoneFlex® spring block





Maximum load of up to 150 kg



## STRONG



 A double-sided mattress  
 Height mm: 190  
 Warranty for the mattress\*  
 Max load for 1 accommodation  
 Mattress rigidity

1. A Stress Free comfort system with an integrated Ultraphil Plus® proofing
2. A mix of sisal fibers and coir
3. A three zoned 3ZoneFlex® spring block
4. Mattress edge support reinforcement system

## VIKING

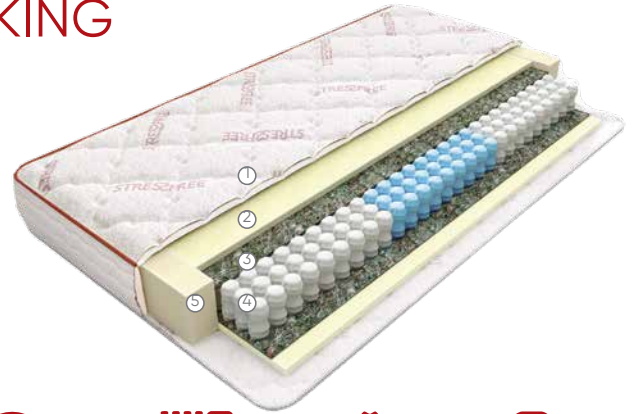

 A double-sided mattress  
 Height mm: 210  
 Warranty for the mattress\*  
 Max load for 1 accommodation  
 Mattress rigidity

1. A Stress Free comfort system with an integrated Ultraphil Plus® proofing
2. A highly elastic memory foam
3. Felt
4. A three zoned 3ZoneFlex® spring block
5. Mattress edge support reinforcement system

## SUMO

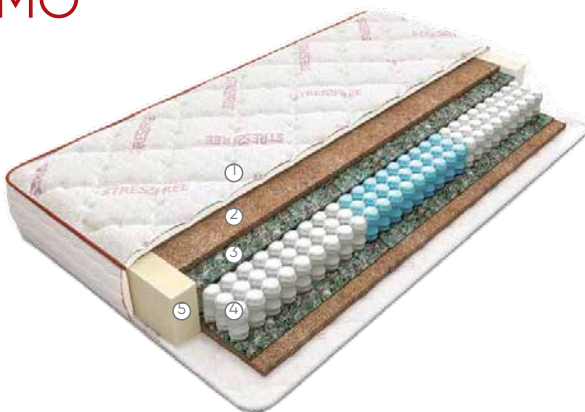

 A double-sided mattress  
 Height mm: 210  
 Warranty for the mattress\*  
 Max load for 1 accommodation  
 Mattress rigidity

1. A Stress Free comfort system with an integrated Ultraphil Plus® proofing
2. A double layer of coir fiber
3. Felt
4. A three zoned 3ZoneFlex® spring block
5. Mattress edge support reinforcement system

## HEAVY



 A double-sided mattress  
 Height mm: 210  
 Warranty for the mattress\*  
 Max load for 1 accommodation  
 Mattress rigidity

1. A Stress Free comfort system with an integrated Ultraphil Plus® proofing
2. Latex
3. Felt
4. A three zoned 3ZoneFlex® spring block
5. Mattress edge support reinforcement system

\* An extended warranty for the purchase of a mattress with a cover.



## STARK

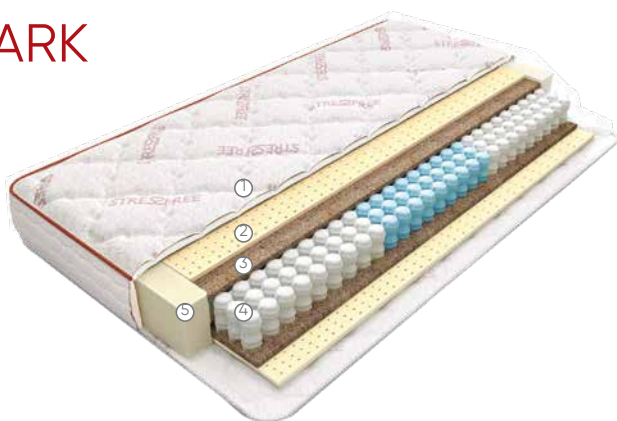

1. A Stress Free comfort system with an integrated Ultraphil Plus® proofing
2. Latex
3. Coir fiber
4. A three zoned 3ZoneFlex® spring block
5. Mattress edge support reinforcement system

## HARD



1. A Stress Free comfort system with an integrated Ultraphil Plus® proofing
2. A highly elastic foam with a cell cutting
3. Coir fiber
4. A highly elastic foam
5. Coir fiber

\* An extended warranty for the purchase of a mattress with a cover.

## ASKONA MEGATREND IS A COLLECTION OF SUPER-DURABLE MATTRESSES.

The exclusive STRESS FREE knitted fabric used for the collection contains a special Ultraphil Plus® proofing which protects the mattress from emergence of harmful microorganisms, mold and dust mites. The fabric structure and point pocket are designed to let human body relax as much as possible during the rest, to ensure a micro-massage effect in order to release the organism from stress.





## A UNIQUE COLLECTION OF MANY-SIDED MATTRESSES



Delicate and cozy velour will make your bed truly warm in winter.



High-quality knitted fabric will help you feel desired coolness in summer heat.



The premium class height of S.O.U.L mattresses adds to the smartness of the bedroom's interior.



## NORMA

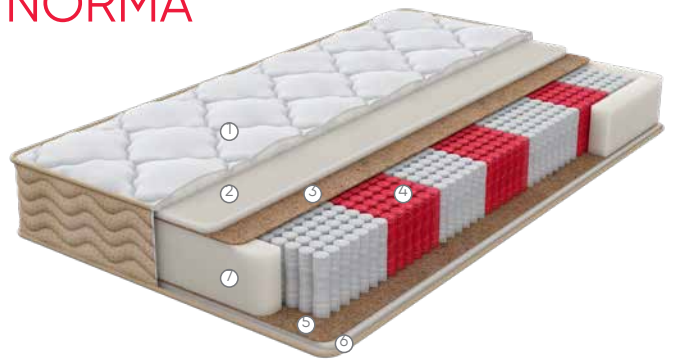

Many-sided mattress



Height mm



Warranty for the mattress\*



Max load for 1 accommodation



Mattress rigidity



1. Velour padded with highly elastic foam
2. A highly elastic foam
3. Coir plate
4. A seven zoned MultiPocket spring system 15 cm
5. A double layer of coir fiber
6. Knitted fabric padded with highly elastic foam
7. Edge reinforcement

## FOCUS



A double-sided mattress



Height mm



Warranty for the mattress\*



Max load for 1 accommodation



Mattress rigidity



1. Velour padded with highly elastic foam
2. A highly elastic foam
3. White felt
4. A seven zoned MultiPocket spring system 15 cm
5. Knitted fabric padded with highly elastic foam
6. Edge reinforcement

## FINES



Many-sided mattress



Height mm



Warranty for the mattress\*



Max load for 1 accommodation



Mattress rigidity









1. Velour padded with highly elastic foam
2. A highly elastic foam with a micro-massage effect
3. Felt
4. A seven zoned MultiPocket spring system 15 cm
5. Coir plate
6. Knitted fabric padded with highly elastic foam
7. Edge reinforcement

\* An extended warranty for the purchase of a mattress with a cover.

## VICTORY







-   
 A double-sided  
mattress
-   
 200  
Height  
mm
-   
 3  
years  
Warranty  
for the mattress\*
-   
 110  
Max load  
for 1  
accommodation



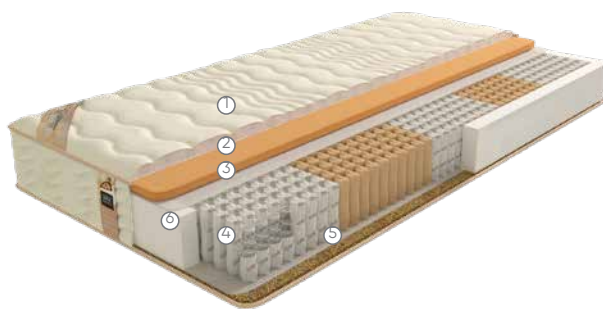

  
 Mattress rigidity

1. Highly elastic foam cotton jacquard.
2. A highly elastic foam
3. Coir fiber
4. A five zoned independent spring block of enhanced rigidity
5. Edge reinforcement

## SUPREMO



-   
 Many-sided  
mattress
-   
 220  
Height  
mm
-   
 25  
years  
Warranty  
for the mattress\*
-   
 140  
Max load  
for 1  
accommodation



  
 Mattress rigidity

1. BioSleep comfort system
2. A highly elastic foam
3. Linen
4. A five zoned Multipocket spring block
5. Coir fiber
6. Edge reinforcement

\* An extended warranty for the purchase of a mattress with a cover.



SENSES MATTRESSES ARE AS CUSTOMIZED TO INDIVIDUAL PREFERENCES AS POSSIBLE AND THEY MAKE SLEEP REVITALIZING



**CottonCare fabric proofing**  
Fabric proofing as a finishing touch for fibers restrains the growth of microorganisms on the fabric and serves as a protective barrier from pathogenic microorganisms and dust mites for the skin. It also has a self-purification property.



**AntistressFoam**  
reduces reverse pressure on the body; it's hypoallergenic, helps to fall asleep quickly and enables good deep sleep.



**HelpSystem**  
drives rejuvenation of certain skin cells which has a favorable effect on a level of skin moisture, tenderness and smoothness

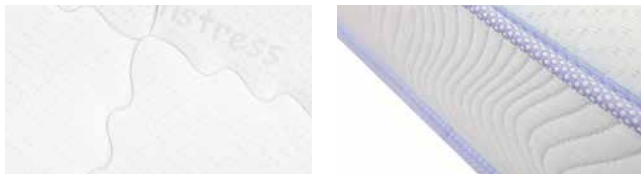

LILY

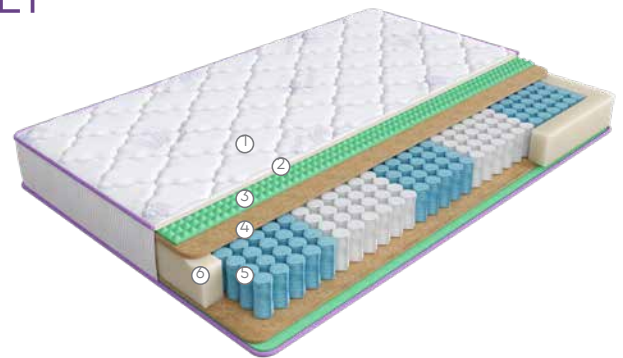

A double-sided mattress



240  
Height mm



Warranty for the mattress\*



Max load for 1 accommodation



Mattress rigidity

1. Highly elastic foam padded knitted fabric with a CottonCare proofing.
2. HelpSystem
3. AntiStress Foam with a massage effect
4. Coir
5. A five zoned ActiveFlex spring block
6. Mattress edge support reinforcement system

VERBENA

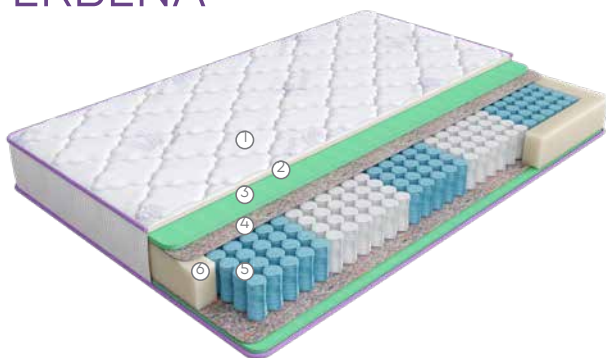

A double-sided mattress



230  
Height mm



Warranty for the mattress\*



Max load for 1 accommodation



Mattress rigidity

1. Highly elastic foam padded knitted fabric with a CottonCare proofing.
2. HelpSystem
3. AntiStress Memory Foam
4. Felt
5. A five zoned ActiveFlex spring block
6. Mattress edge support reinforcement system

VIOLET

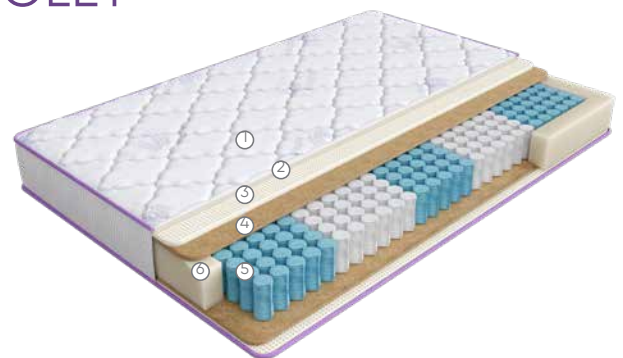

A double-sided mattress



250  
Height mm



Warranty for the mattress\*



Max load for 1 accommodation



Mattress rigidity

1. Highly elastic foam padded knitted fabric with a CottonCare proofing.
2. HelpSystem
3. Latex
4. Coir
5. A five zoned ActiveFlex spring block
6. Mattress edge support reinforcement system

\* An extended warranty for the purchase of a mattress with a cover.





## THE COLLECTION IS DESIGNED FOR THE PEOPLE THAT ALWAYS STRIVE TO STAY FIT

As scientific researches have shown, inadequate sleep leads to overeating and body malfunction which increases a risk of coronary vascular diseases, obesity and depression. A lack of sleep results in a sharp increase of ghrelin, the hormone responsible for appetite.

This discovery makes us have another look at the concept of a healthy lifestyle. If you want to be beautiful and lean, exercises and diets are not enough. It's very important to take care of the amount and quality of sleep.

The Askona Fitness collection is designed for the people that strive to stay fit.



A comfort system with a NANOTex proofing  
It restrains the growth of microorganisms on the fabric. It doesn't absorb surplus moisture and ensures a good ventilation at the same time.



Safe materials  
Environmentally friendly and hypoallergic materials are used.



Full relaxation during the sleep  
Only safe foam certified according to the European CertiPUR standard is used. No chemical agents



A seven zoned Fitness spring block  
The zones are based on Sandglass Springs that provide a solid support for heavier body parts



Askona Fitness mattresses have been successfully tested in the Quality Control Laboratory.

At the stage of assembly a mattress is subject to examination and measurement no less than 5 times!



## ARENA

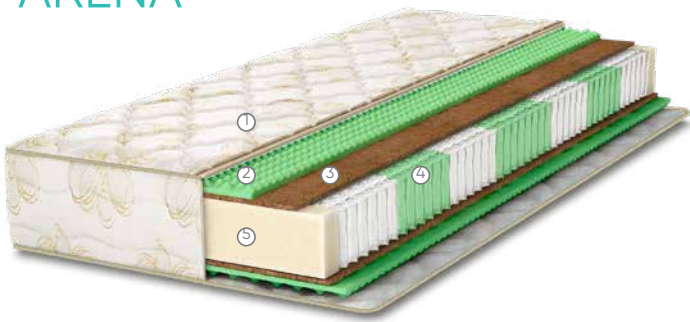



 A double-sided mattress  
 Height mm  
 Warranty for the mattress\*  
 Max load for 1 accommodation

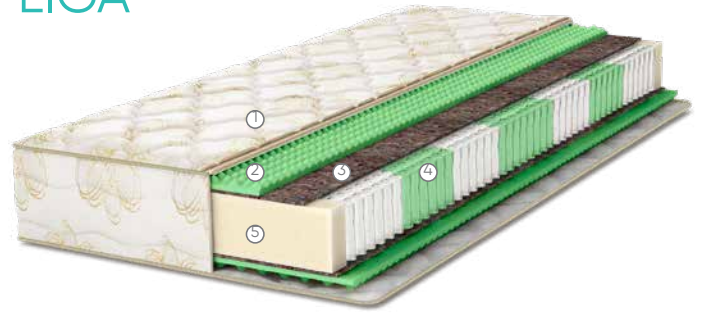

1. A comfort system with a NANOTex fabric
2. Orto Foam® with a proofing generated from the green tea extract and a micro-massage effect
3. Coir fiber
4. A seven zoned Fitness 7 Zoned spring block
5. Edge reinforcement

## LIGA



 A double-sided mattress  
 Height mm  
 Warranty for the mattress\*  
 Max load for 1 accommodation



1. A comfort system with a NANOTex fabric
2. Orto Foam® with a proofing generated from the green tea extract and a micro-massage effect
3. Felt
4. A seven zoned Fitness 7 Zoned spring block
5. Edge reinforcement

## FORMULA

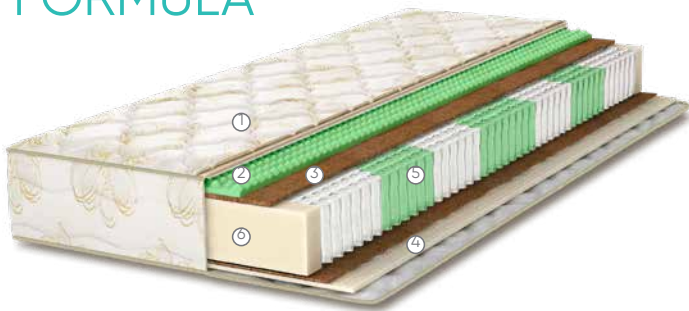

 A double-sided mattress  
 Height mm  
 Warranty for the mattress\*  
 Max load for 1 accommodation



1. A comfort system with a NANOTex fabric
2. Orto Foam® with a proofing generated from the green tea extract and a micro-massage effect
3. Coir fiber
4. Latex
5. A seven zoned Fitness 7 Zoned spring block
6. Edge reinforcement

## IDEA

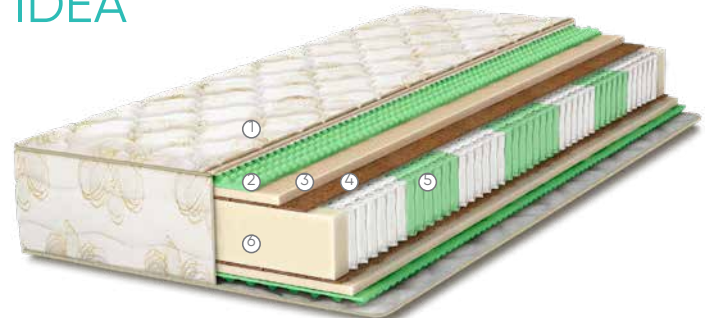

 A double-sided mattress  
 Height mm  
 Warranty for the mattress\*  
 Max load for 1 accommodation



1. A comfort system with a NANOTex fabric
2. Orto Foam with a proofing generated from the green tea extract and a micro-massage effect
3. Latex
4. Coir fiber
5. A seven zoned Fitness 7 Zoned spring block
6. Edge reinforcement

\* An extended warranty for the purchase of a mattress with a cover.



## EXPERIENCE A TRULY LUXURIOUS SLEEP

Mattresses of the most famous American brand with 80 years of experience. A combination of aesthetics, noble materials and the cutting-edge technologies.



**SoftFeel proofing**  
It makes the fabric incredibly soft and luxurious.



**UltraSense comfort system**  
It increases air circulation for a perfect microclimate of the sleeping accommodation



**SoyaFoam, a foam of a new generation**  
It's a material of increased density and durability









**A Serta Support System spring block**  
It's more resilient than other blocks and can endure a greater load due to increased spring compression.

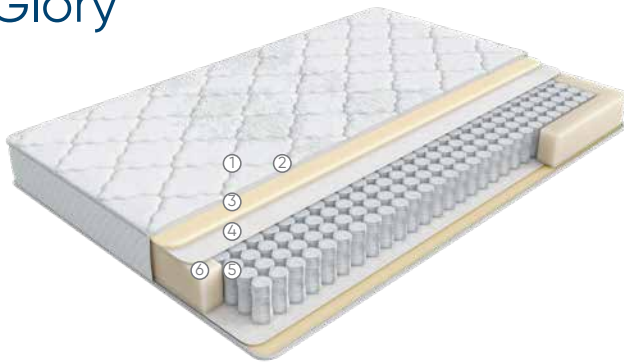



## Glory



 A single-sided mattress  
 Height mm  
 Warranty for the mattress\*  
 Max load for 1 accommodation  
 Mattress rigidity

1. Premium knitted fabric with an ultra soft SoftFeel proofing
2. The UltraSense comfort system creates a favorable microclimate in the mattress
3. SoyaFoam
4. Linen
5. A Serta Support System spring block, h-18 cm
6. Mattress edge support reinforcement system

## Liberty

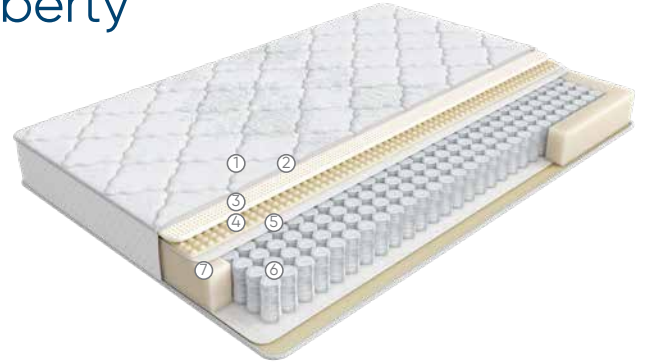





 A single-sided mattress  
 Height mm  
 Warranty for the mattress\*  
 Max load for 1 accommodation  
 Mattress rigidity

1. Premium knitted fabric with an ultra soft SoftFeel proofing
2. The UltraSense comfort system creates a favorable microclimate in the mattress
3. Latex
4. High-volume Super Soft foam with a massage effect
5. Linen
6. A Serta Support System spring block, h-18 cm
7. Mattress edge support reinforcement system

## Grace



 A single-sided mattress  
 Height mm  
 Warranty for the mattress\*  
 Max load for 1 accommodation  
 Mattress rigidity

1. A comfort system due to premium knitted fabric and an ultra soft SoftFeel proofing
2. The UltraSense comfort system creates a favorable microclimate in the mattress
3. SoyaFoam memory foam
4. High-volume Super Soft foam with a massage effect
5. Linen
6. A Serta Support System spring block
7. Mattress edge support reinforcement system

## Emily



 A single-sided mattress  
 Height mm  
 Warranty for the mattress\*  
 Max load for 1 accommodation  
 Mattress rigidity

1. Premium knitted fabric with an ultra soft SoftFeel proofing
2. The UltraSense comfort system creates a favorable microclimate in the mattress
3. SoyaFoam
4. High-volume Super Soft foam
5. Linen
6. A Serta Support System spring block, h-15 cm
7. Mattress edge support reinforcement system

\* An extended warranty for the purchase of a mattress with a cover.



## COLLECTION OF CHILDREN MATTRESSES MOM'S LOVE

The collection of Mom's Love mattresses is notable for a strong foundation and suits growing kids and teenagers perfectly.

Due to child friendly design your kid will sleep comfortably and cozy during the night.

Natural and safe materials will ensure comfortable sleep during the entire time your child stays in bed

Mom's Love Collection – encompassing with mother's love since childhood.



100% hypoallergenicity



Safe and high quality materials

## BABY

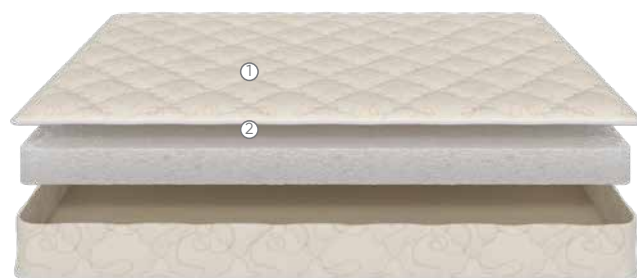

A double-sided mattress



Height mm



Warranty for the mattress\*



Max load for 1 accommodation



Mattress rigidity

1. A pure cotton cover padded with polyether fiber
2. Periotek® Form – a safe material

## CHILD

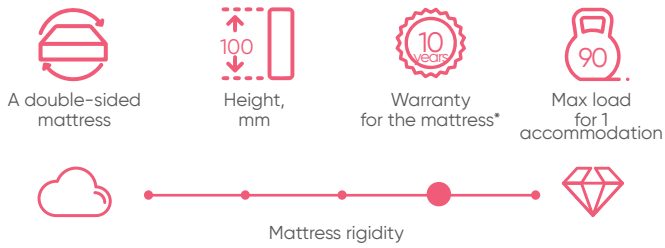
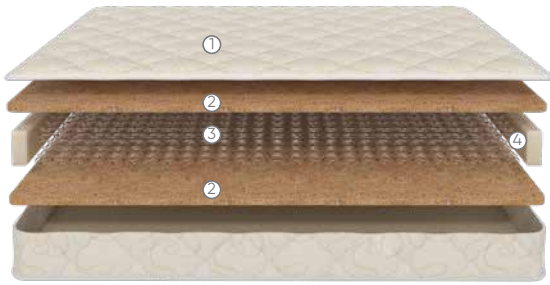

1. A pure cotton cover padded with polyether fiber
2. Coir 1 cm
3. Bonnel spring block h-7 cm
4. AirFoam Technology bed case

## JUNIOR

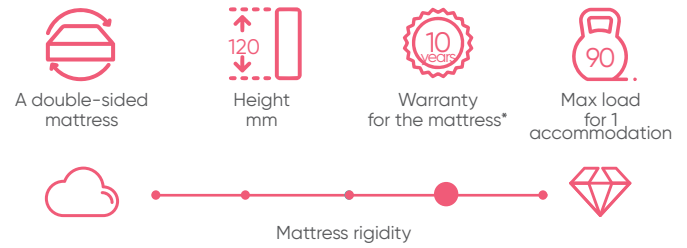
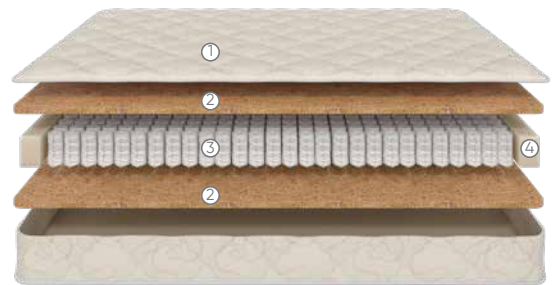

1. A pure cotton cover padded with polyether fiber
2. Coir 1 cm
3. Minipocket spring block, h-7.5 cm
4. AirFoam Technology bed case

## YOUNG

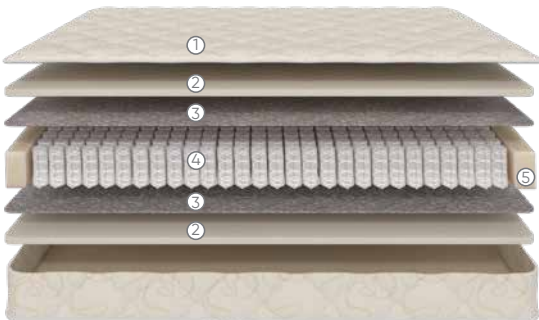

1. A pure cotton cover padded with polyether fiber
2. AirFoam Technology
3. Felt
4. Minipocket spring block, h-7.5
5. AirFoam Technology bed case

## TEENAGER

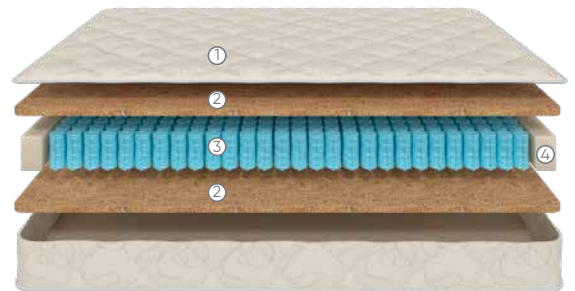

1. A pure cotton cover padded with polyether fiber
2. Coir
3. POKET spring block, h-12 cm
4. AirFoam Technology bed case

\* An extended warranty for the purchase of a mattress with a cover.





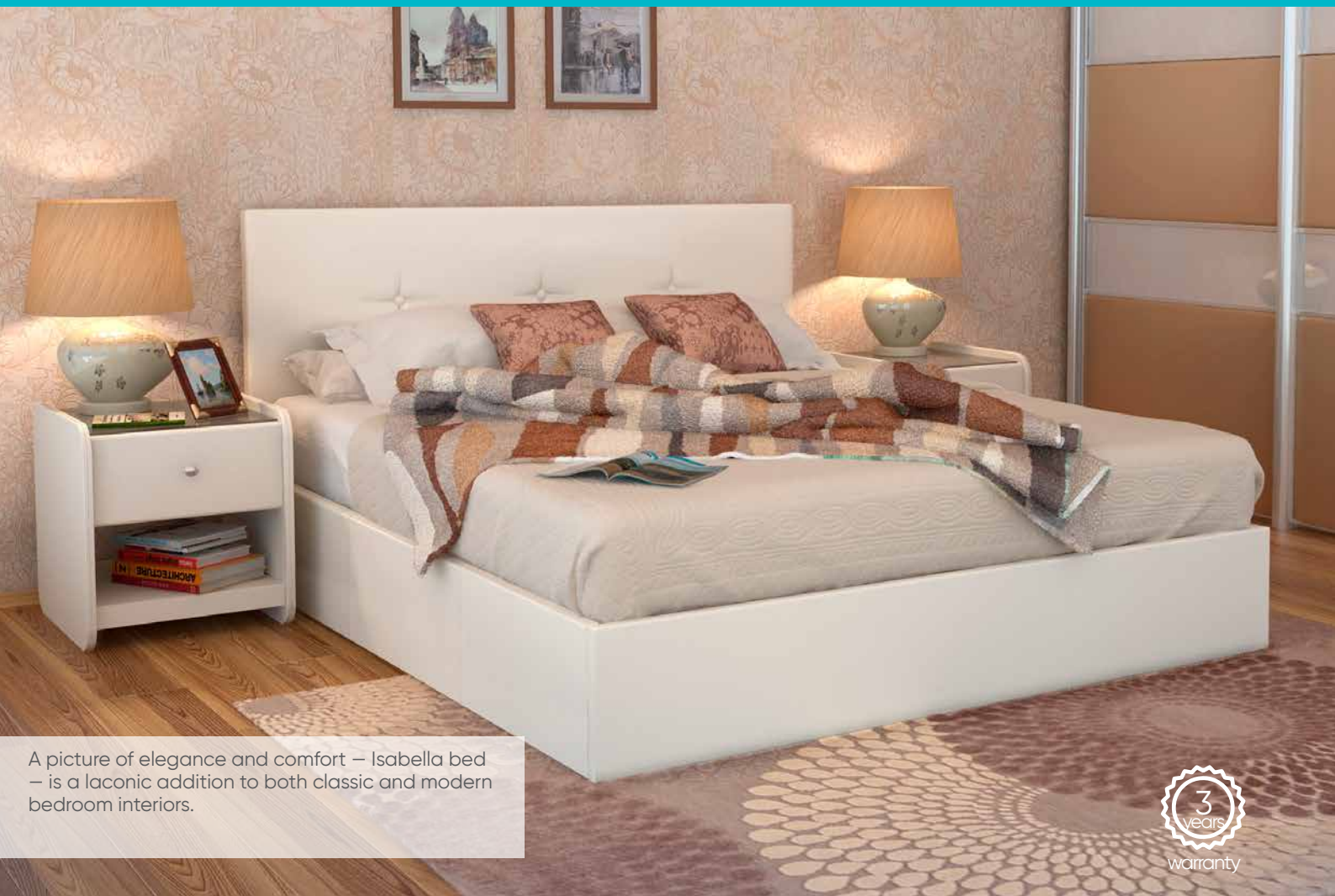

A picture of elegance and comfort – Isabella bed – is a laconic addition to both classic and modern bedroom interiors.



## ISABELLA

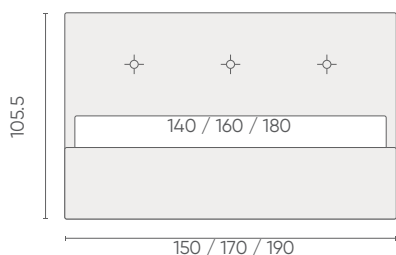
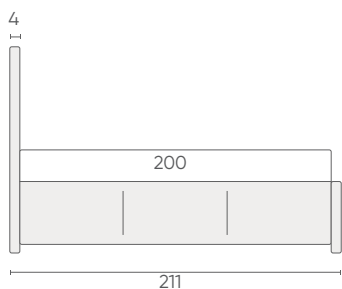

Set



Base with flexible lamellas



Base with a linen storage box

Recommended fabrics

Amelia Lux 246



Casanova Milk



Vogue Stone





# BEDS

Greta is created for those who appreciate laconic modern shapes. The bed is simple and stylish, with clear lines of the headboard.

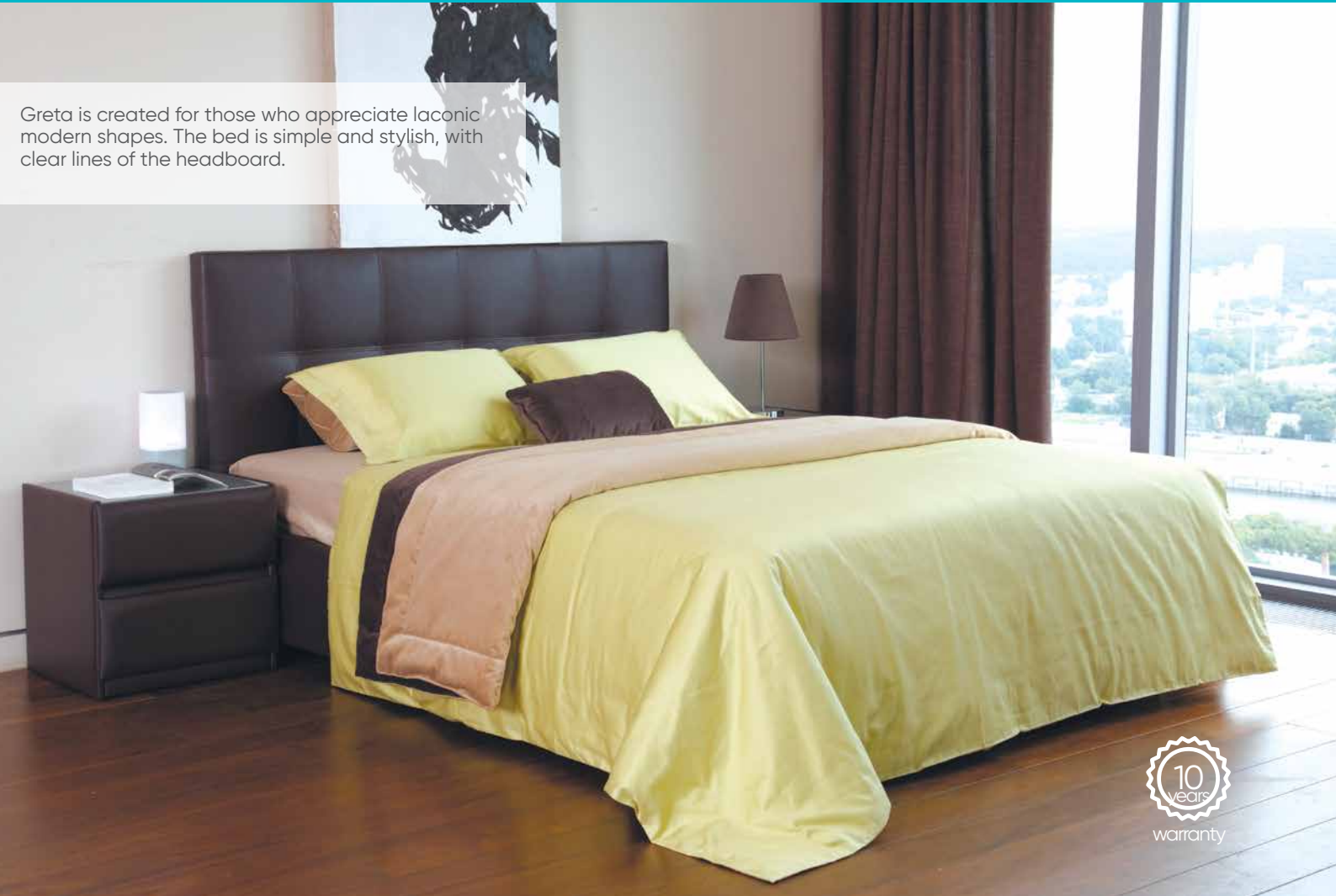

## GRETA

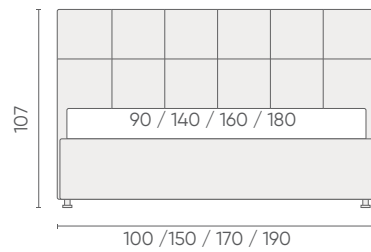
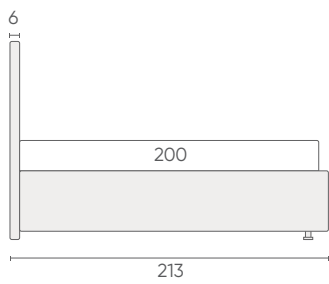

Set



Base with flexible lamellas



Base with a linen storage box

Recommended fabrics

Casanova Lilac



Iris 511



Brera 57







A glamorous and showy Marlena is a model to create a sense of coziness and style at the same time. With such a bed your interior is worth being on a page of some glossy design magazines.



## MARLENA

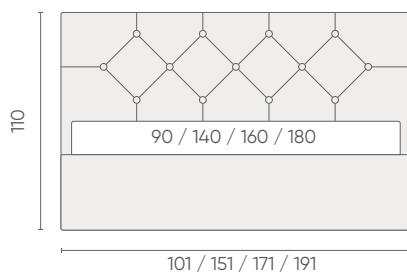
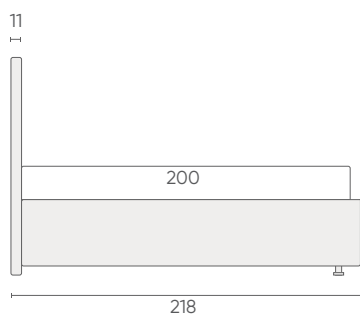

Set



Base with flexible lamellas



Base with a linen storage box

Recommended fabrics

Sky Velvet 99



Casanova Rose



Plazma Vega



# BEDS



Amelia interior bed is a true decoration of the bedroom. The model is notable for simple lines and elegantly curved forms.



warranty

## AMELIA

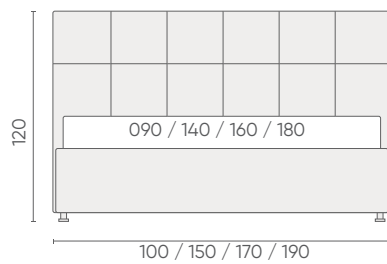
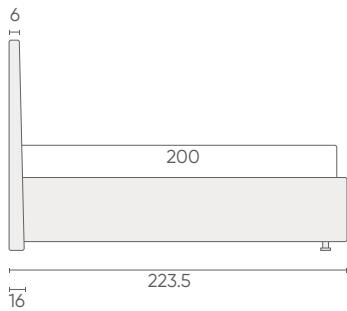

Set



Base with flexible lamellas



Base with a linen storage box



Removable subframe covers

Recommended fabrics

Arbus Cashmere



Casanova Chocolate



Sky Velvet 41





## CLASSIC 1

Bedside table

The best solution for your comfort: all the personal items are always at your fingertips!

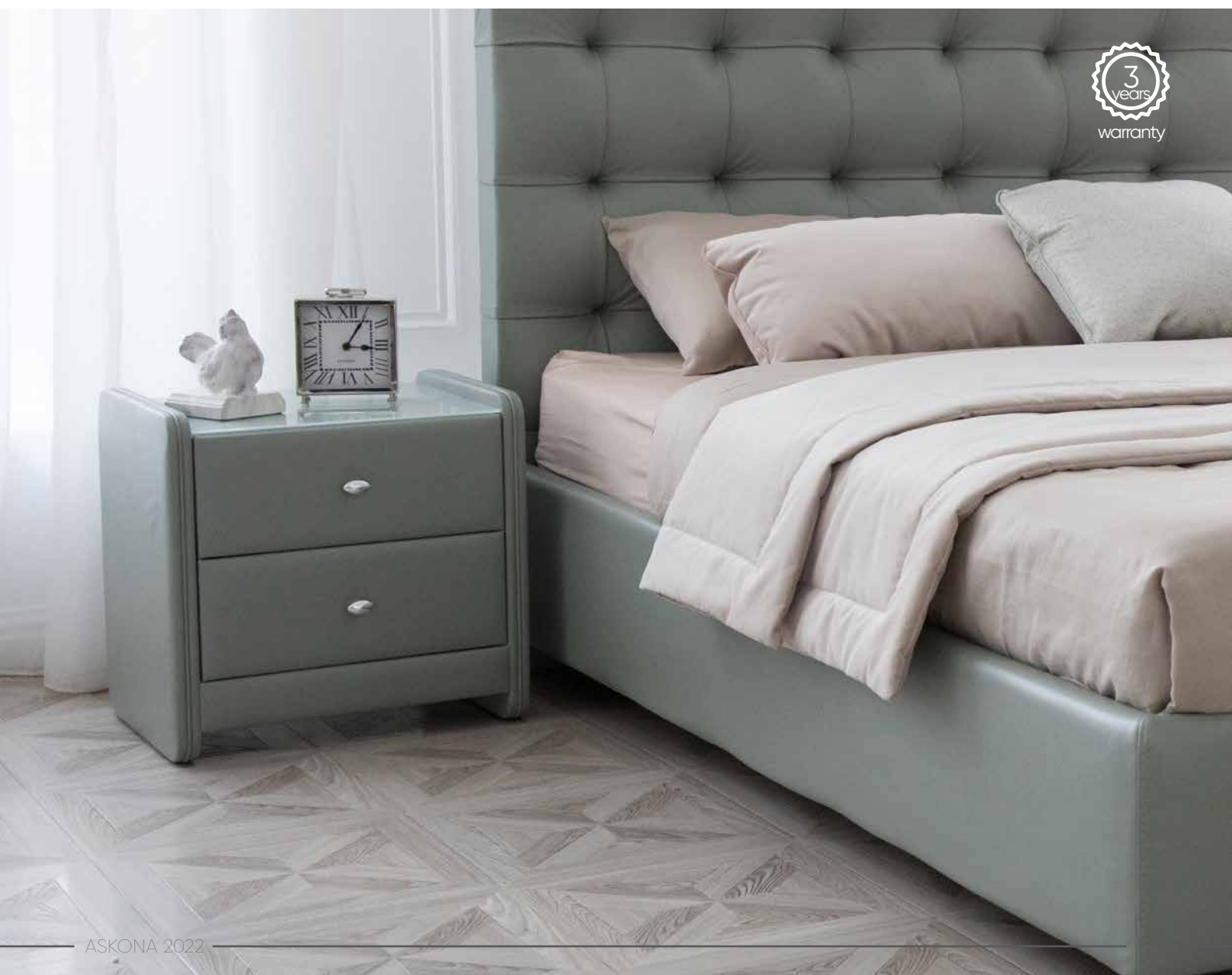
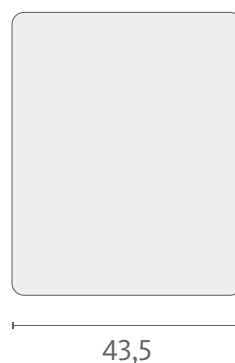
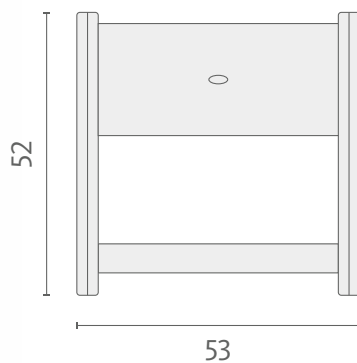

3  
years  
warranty





## UPHOLSTERY MATERIALS FOR INTERIOR BEDS

Dorio \_\_\_\_\_ corduroy, 2nd category



beige

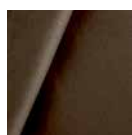

brown

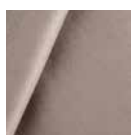

grey

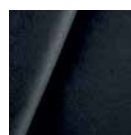

grazit

Amelia Lux \_\_\_\_\_ basket cloth, 2nd category



243



244



246



247

Iris \_\_\_\_\_ basket cloth, 2nd category



205      507      511      604      902

Brera \_\_\_\_\_ basket cloth, 2nd category

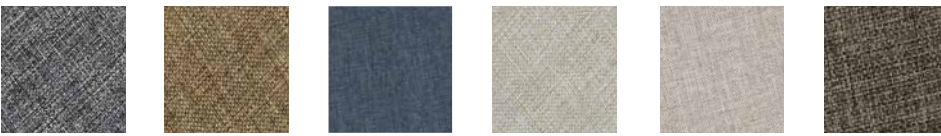

31      39      47      56      57      81

Casanova \_\_\_\_\_ microfiber, 3rd category



milk      beige      chocolate      grey      lilac      sky      seawave      stone      rose



brick      marsala      yellow

Sky Velvet \_\_\_\_\_ microfiber, 3rd category



01      02      03      07      08      10      16      17      21



30      38      40      41      42      43      50      99

Arbus \_\_\_\_\_ basket cloth, 3rd category



arcticblue      carob      carry      cashmere      field      icegrey      peat

Plazma \_\_\_\_\_ eco-leather, 4th category

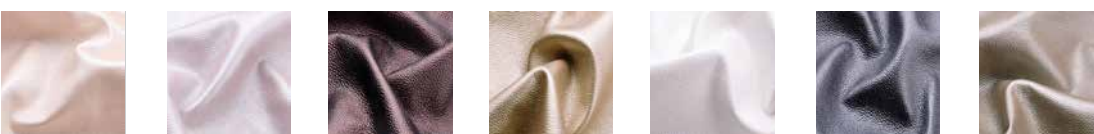

milky way      moon      ngs 604      venera      oxygen      platina      vega

# CABINET FURNITURE

A classic design of the headboard makes the bed a central element of a cozy bedroom.

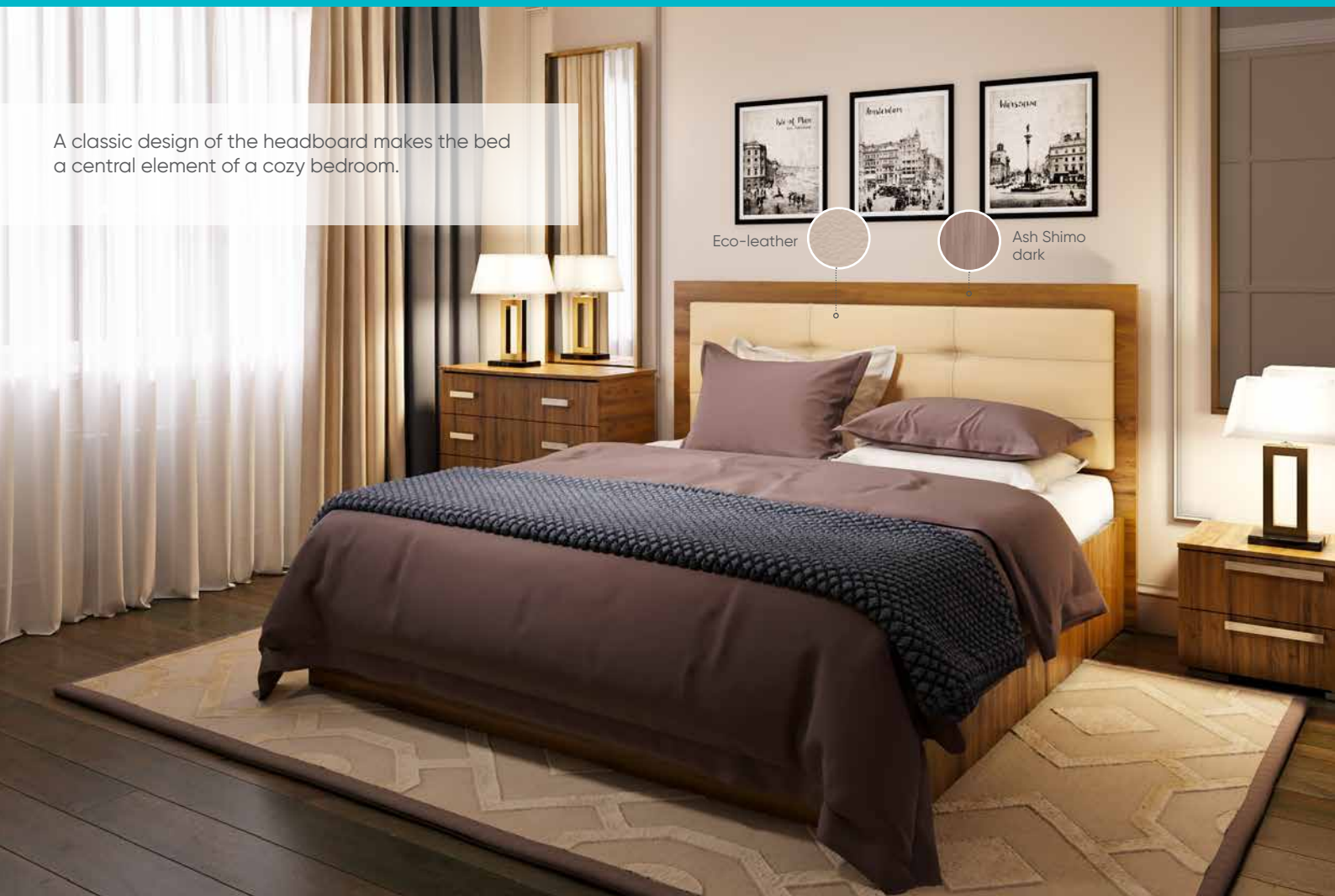

Eco-leather

Ash Shimo dark

## FRIDA

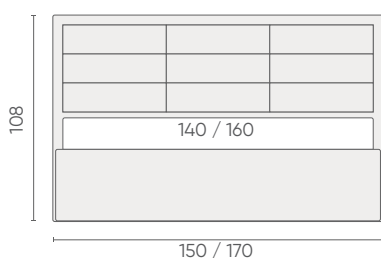
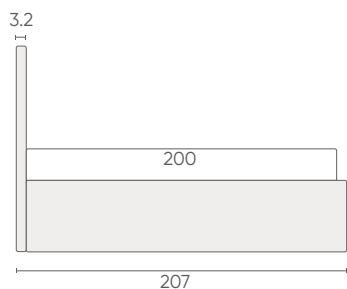

Set .....



Base with a linen storage box (floor bed)



Base laminated chipboard (a "floating" bed)

## CABINET FURNITURE FOR THOSE WHO APPRECIATE RELIABILITY, SAFETY AND PERFORMANCE!



High-quality, solid and durable



They are made of safe materials produced by the Austrian company with a Germany manufacturing quality



No special care is required



The items can be easily combined both with the furniture combined with fabric/leather and wooden furniture



Warranty



A unique contour of the headboard in the shape of a chocolate bar adds to the interior's aesthetics and sophistication

Basket cloth  
Ash Anchor light

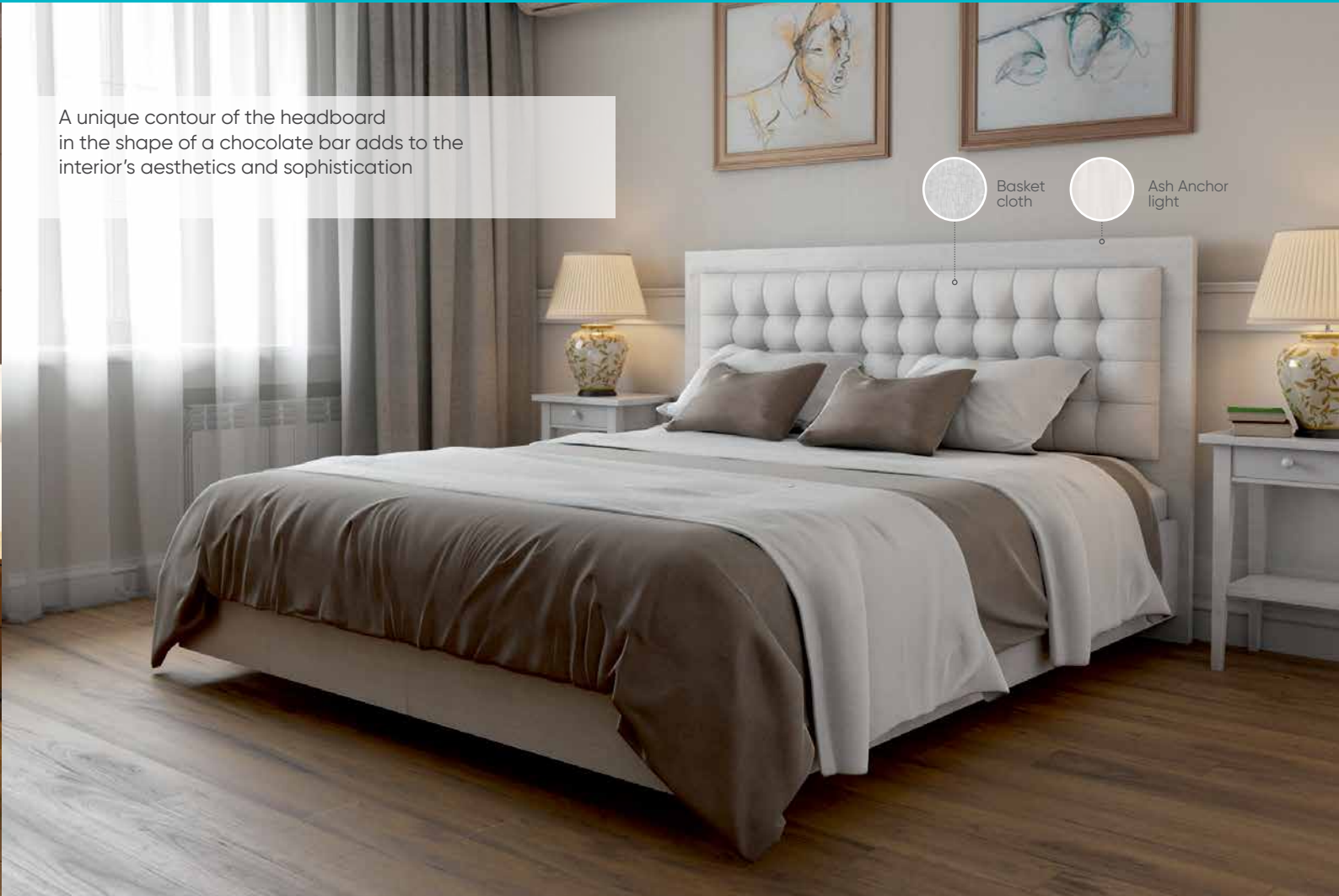

## DALIA

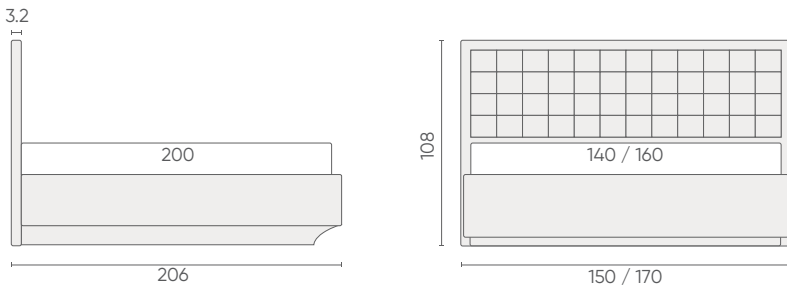

Set .....



Base with a linen storage box (floor bed)



Base laminated chipboard (a "floating" bed)

## drawer chest LAGUNA

Width: 920 mm  
Depth: 475 mm  
Height: 820 mm

Ash Shimo (dark) Ash Anchor (light)



## bedside table LAGUNA

Width: 550 mm  
Depth: 428 mm  
Height: 422 mm

Ash Shimo (dark) Ash Anchor (light)





## HELIX NEW CONVERTIBLE SOFA

A low-key and laconic sofa will fit in a modern interior perfectly. Rectangular laminated armrests look sophisticated and complement square shaped geometrical stitching.

The frame made of a strong and solid metal will let your sofa be in use for many years. Serpentine springs are used in the seat frame which makes it look perfectly smooth. The anatomic mattress made of form-stable Power Foam will ensure healthy sleep.

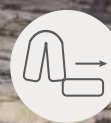

Mechanism:  
Accordion

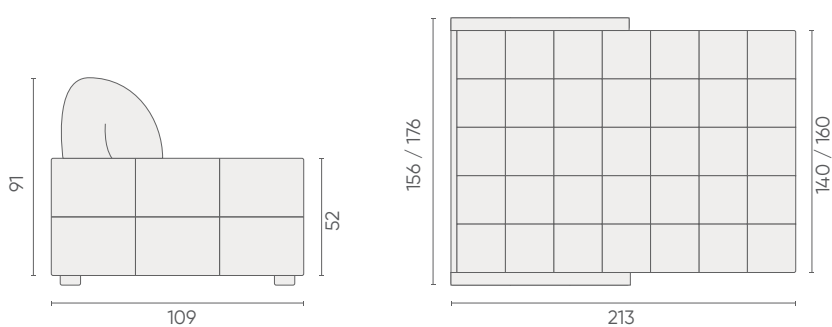

Mechanism: Accordion

The width of the sleeping accommodation can be chosen: 210\*140, 210\*160 cm

Base: birch lamellas + a Serpentine Spring

Mattress: anatomic, made of form-stable Power Foam

Accommodation load: up to 110 kg

Linen storage box: no

Warranty: 18 months

### Recommended fabrics

Arbus IceGrey

Brera 47

Iris 604

Casanova Milk





# PROTECTIVE COVERS

## BENEFITS OF COVERS



Protection from bed-bugs



It doesn't cause allergy



Protection from water



Extends the mattress life-cycle



Noiseless



Breathable fillings



## ASKONA

- Smooth knitted fabric upholstery (100% polyester)
- Side parts (torse) – 100% polyester
- Durable (it can endure up to 200 wash cycles)
- Machine washing at a high temperature (up to 50°C) and drying in a medium mode



## EASY COVER NEW

- Elastic fastening
- Surface – 100% polyester
- Durable – it can endure up to 100 wash cycles
- Machine washing at a high temperature (up to 50 degrees)



## DAILY COVER NEW

- Elastic fastening
- Surface – 100% polyester
- Durable – it can endure up to 100 wash cycles
- Machine washing at a high temperature (up to 50 degrees)



## PROTECT-A-BED PLUSH

- Soft velour surface (100% polyester), a zip fastening
- Durable (it can endure up to 100 wash cycles)
- Machine washing at a high temperature (up to 50°C) and drying in a medium mode



## PROTECT-A-BED KIDS

- The surface is made of terry cotton – a completely hypoallergic material (80% cotton, 20% polyester)
- Side parts (torse) – 100% polyester
- Durable – it can endure up to 100 wash cycles
- Machine washing at a high temperature (up to 50 degrees)



## COTTON COVER

- The surface is made of terry cotton (80% cotton, 20% polyester)
- Side parts (torse) – 100% polyester
- Durable (it can endure up to 200 wash cycles)
- Machine washing at a high temperature (up to 50°C) and drying in a medium mode

## PLUSH COVER

- Soft velour surface (100% polyester)
- Side parts (torse) – 100% polyester
- Durable (it can endure up to 100 wash cycles)
- Machine washing at a high temperature (up to 50°C) and drying in a medium mode

## ORIGINAL COVER

- A soft surface (100% polyester)
- Side parts (torse) – 100% polyester
- Durable (it can endure up to 100 wash cycles)
- Machine washing at a high temperature (up to 50°C) and drying in a medium mode



Safe materials are used



It can be adjusted for the head's position



Easy to take care of



Full relaxation during the sleep

## FOSTA



- Knitted fabric cover (100% polyester)
- Filling – Memorix Memory Foam

Size: 40x60 cm

## GLOW



- A microfiber cover (100% polyester)
- A latex filling
- A polyether filling

Size: 50x70 cm

## TEMP CONTROL



- Coolpepe knitted fabric cover (with a cooling effect) 100% polyester
- The internal cover is made of cotton.
- Filling – Taktile innovative material

Size: 50x70 cm

## ORGANIC



- External cover: Tencel knitted fabric (50% eucalyptus-based fiber, 50% polyether fiber)
- Internal cover: Microfiber
- Filling: 10% Aerobamboo

Size: 50x70 cm

## CALIPSO



- Cover: microfiber (100% polyester)
- Filling of the cover: 50% eucalyptus-based fiber, 50% polyester
- Pillow filling: Aerobamboo

↕ Size: 50x70 cm

## COTTON



- External cover: Ticking/Sateen (100% cotton)
- Filling: synthetic swan's down (100% polyether)

↕ Size: 50x70 cm

## REVOLUTION



- External cover: microfiber with carbon threads
- Internal cover: padded polycotton with moss foam
- Filling: Latex Spring

↕ Size: 50x70 cm

## **NEW** ASKONA REVOLUTION



- External cover: ticking/sateen (100% cotton)
- Internal cover: moss foam padded microfiber (100% polyester)
- Filling: latex + polyether (100% polyether)

↕ Size: 50x70 cm

## SPRING PILLOW



- External cover: microfiber
- Internal cover: polycotton.
- Filling: polyether fiber  
an independent pocket mini-spring block, a MediFoam layer

↕ Size: 50x70 cm

## **NEW** ASKONA SPRING PILLOW



- External cover: PILLOW knitted fabric (viscose)
- Internal cover: microfiber (100% polyester)
- Filling: an independent pocket mini-spring block, polyether fiber

↕ Size: 50x70 cm





## DENNY



Designed  
for children of five  
years and upward



Size:  
59x39x9 cm

A classic pillow for children of five years and upward. It suits for sleeping on the side and on the back. A memory effect allows the pillow adjusting to the individual bend of a cervical spine to ensure its complete relaxation. And the improved combination of the material's thickness and flexibility and the smooth surface of the basis normalizes the muscle tone and drives vascular supply to ensure the best possible comfort and elimination of fatigue while sleeping.



## TEPLO BLANKET

- Fabric of the cover: microfiber (100% polyester)
- Filling: 100% polyether fiber

FILLING DENSITY IS 360 M<sup>2</sup>



Size: 205x140, 205x172, 220x200 cm



LIGHTWEIGHT



EASY TO  
TAKE CARE OF



WINTER



## SIMPLE BLANKET

- Fabric of the cover: microfiber (100% polyester)
- Filling: Hollowtech Lux

FILLING DENSITY IS 150 M<sup>2</sup>



Size: 205x140, 205x172, 220x200 cm



BREATHABLE



SOFT AND  
RESILIENT



EASY TO TAKE  
CARE OF



## CALIPSO BLANKET

- Fabric of the cover: microfiber (100% polyester)
- Filling: 50% eucalyptus-based fiber, 50% polyether hollow fiber

FILLING DENSITY IS 180 M<sup>2</sup>



Size: 205x140, 220x200 cm



SAFE  
MATERIALS



SOFT AND  
DELICATE



2022

[www.askona.ru/sleeptolive](http://www.askona.ru/sleeptolive)